

TECHNICAL SPECIFICATION:

- 3V battery type CR2450
- battery life < 3 years
- frequency 433.92MHz
- transmit power max. 10mW
- transmit range indoor max. 30mtr
- working temperature -10°C - +50°C
- each channel can control up to 20 receivers

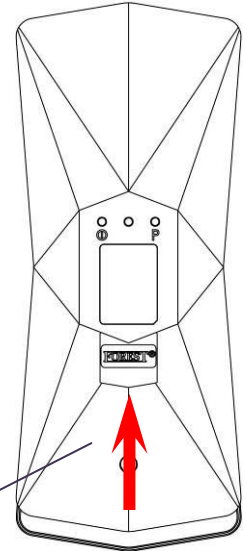
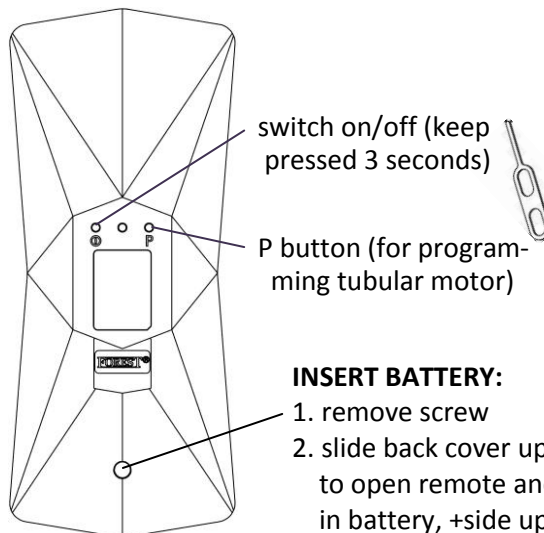
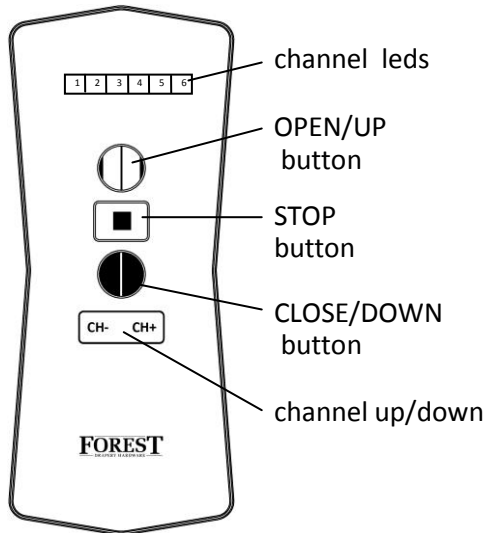

INSERT BATTERY:

1. remove screw
2. slide back cover upwards to open remote and slide in battery, +side up



BATTERY EMPTY:

After changing the battery, programmed receivers will stay in memory of wall switch. Please follow the local regulations for disposal of the empty battery.

You can recognize these Shuttle motors by the white antenna cable

To program a RF wall switch to a Shuttle S / L / M Receiver:

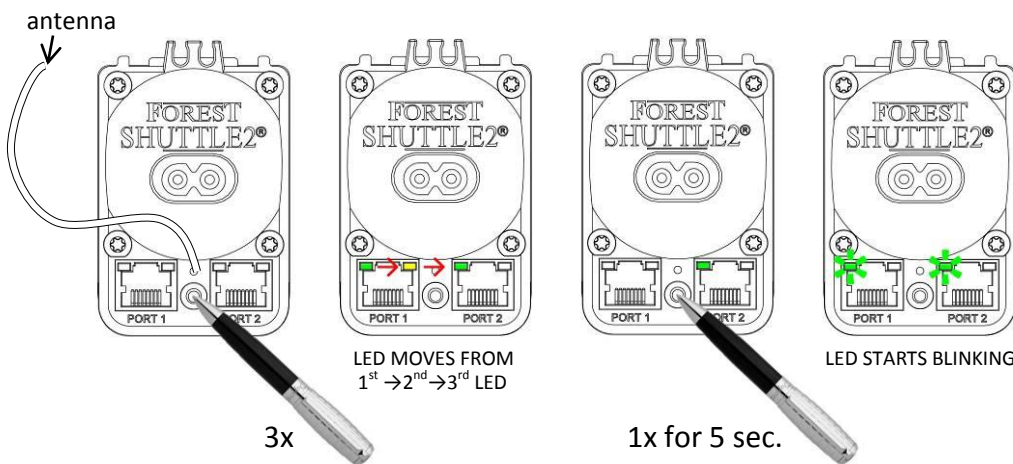

Same procedure, but press CLOSE instead of OPEN, will erase the programmed channel.



Do not mount the motor within 1 meter from other equipment and receivers. This will interfere with the receiver.

TECHNICAL SPECIFICATION:

- powered by Shuttle M
- connect to port 1 of the Forest Shuttle M
- working temperature -10°C - +50°C
- controlled by Forest Multi Remote and Forest Multi Wall Switch RF

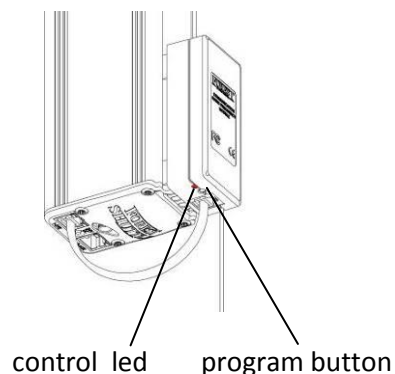

Do not mount within 1 meter from other equipment and receivers.
This will interfere with the receiver.

PROGRAMMING WALL SWITCH TO CLICK-ON RECEIVER:



press program button,
led will light up

hold the wall switch within 2 mtr
from receiver. Select channel
and press OPEN button

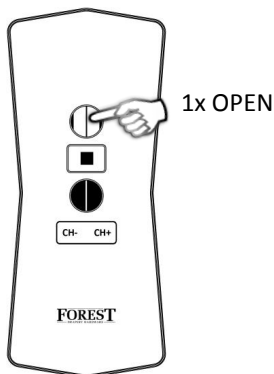

on receiver:
led blinks 3 times and will go off

REMOVE PROGRAMMED CHANNEL:



press program button,
led will light up

select (to be cancelled) channel
and press CLOSE button

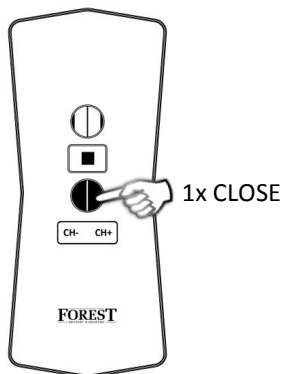

on receiver:
led will blink once and will go off

DELETE ALL PREVIOUS PROGRAMMED CHANNELS:



press and hold the program
button for 10 seconds until
control led starts blinking

TECHNICAL SPECIFICATION SHUTTLE M RECEIVER:

- powered by Shuttle M
- can also be used as wall switch
- cable 0,5mtr → 5201001360
- cable 3,5mtr → 5201001361
- connect to port 1 of the Forest Shuttle M
- working temperature -10°C - +50°C
- controlled by Forest Multi Remote and Forest Multi Wall Switch RF

TECHNICAL SPECIFICATION FMS/BCS RECEIVER:

- power 230Vac – 500W
- controls one tubular or FMS motor
- can also be used as wall switch
- terminal max 2,5mm²
- working temperature -10°C - +50°C

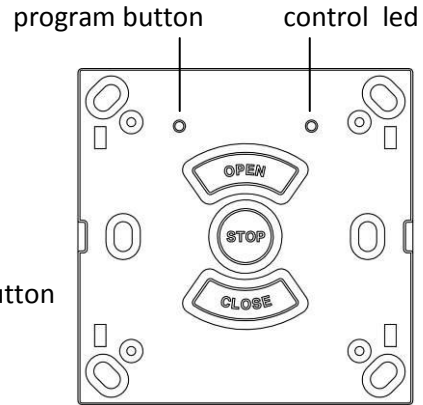
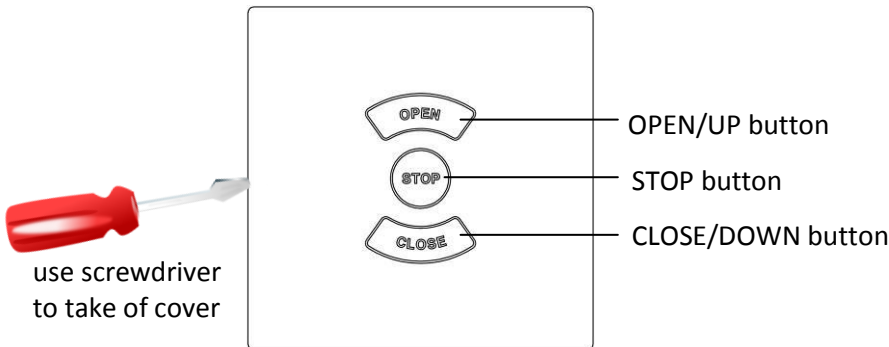

PROGRAMMING REMOTE TO RECEIVER:

press program button, led will blink

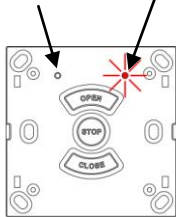

press STOP button

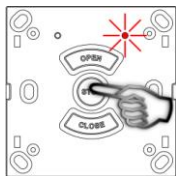

hold the remote within 2 mtr from receiver. Select channel and press OPEN button:

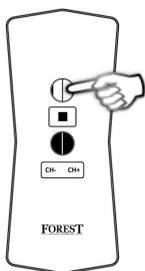

led blinks 3 times and will go off:

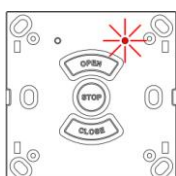

REMOVE PROGRAMMED CHANNEL:

press program button, led will blink

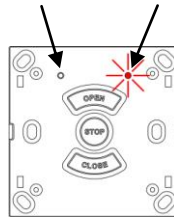

press STOP button

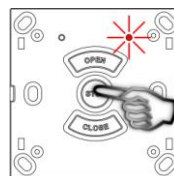

select (to be removed) channel and press CLOSE button:

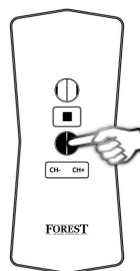

led will blink once and will go off:

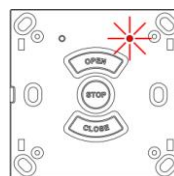

DELETE ALL PREVIOUS PROGRAMMED CHANNELS:

press STOP and CLOSE button of receiver for ~6 sec.

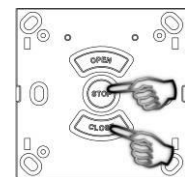

led will blink and will go off

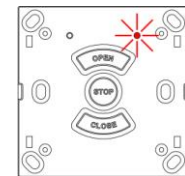

Do not mount within 1 meter from other equipment and receivers. This will interfere with the receiver.

PROGRAMMING REMOTE TO TUBULAR MOTOR:

press button on motor, motor will
turn short to acknowledge

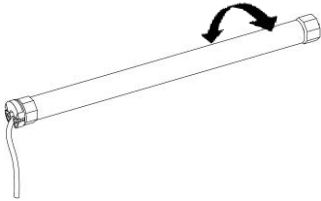

within 6 seconds:

press P button two times

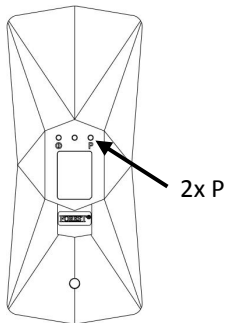

press OPEN button one time

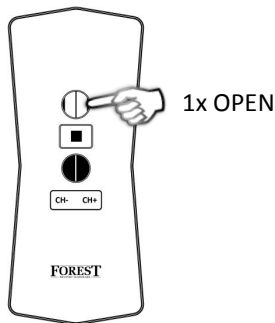

motor will turn to acknowledge

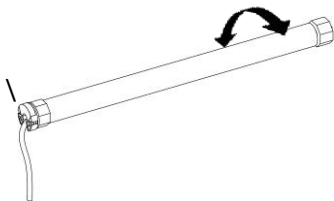

CHANGING DIRECTION OF ROTATION:

To change the direction of rotation,
keep green button on motor pressed
for 7 sec, until motor turns to
acknowledge.

ADD MORE REMOTES OR CHANNELS TO TUBULAR MOTOR

①st remote: press P button two times

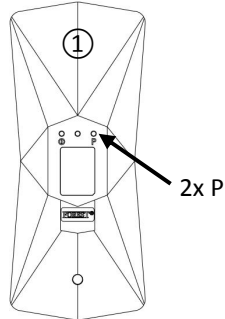

②nd remote: press P button one time

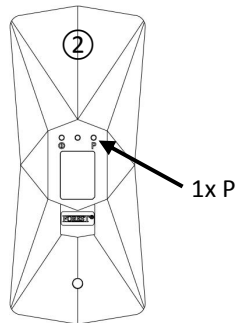

motor will turn to acknowledge

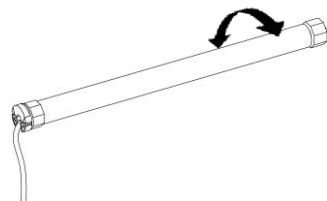

to add an other channel:

- 1.press 2xP button of programmed channel,
- 2.select other channel and press P button

motor will turn to acknowledge

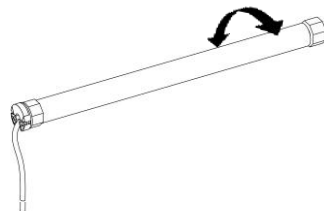

CANCEL ALL REMOTES

press P button one time

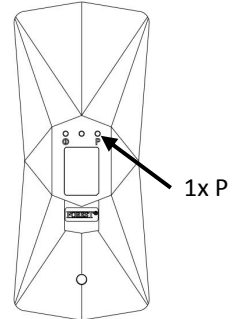

press STOP button one time

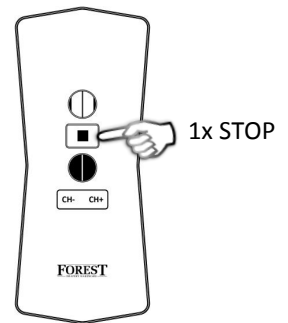

press P button one time

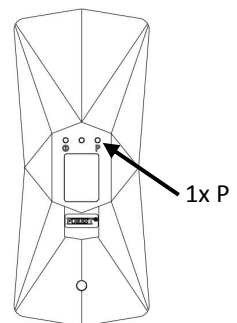

motor will turn to acknowledge

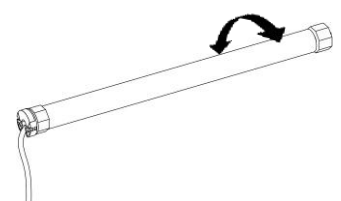

ADJUSTING UPPER AND LOWER END LIMITS:



IMPORTANT: - when more motors are programmed to one channel, end limits of all motors will be adjusted
 - during programming, keep the remote within 2 mtr from the receiver/motor

press P button one time

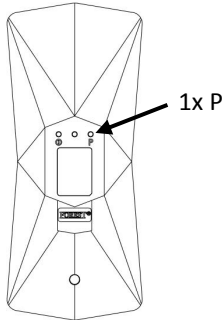

press OPEN button one time

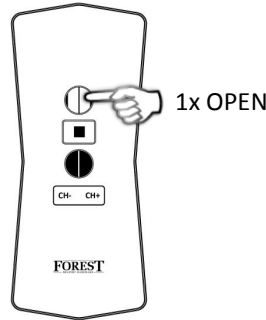

press P button one time

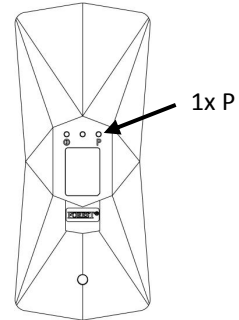

motor will turn to acknowledge

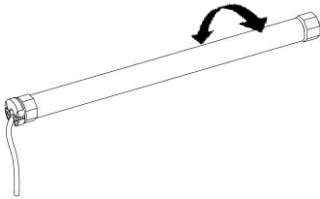

adjust to UPPER position

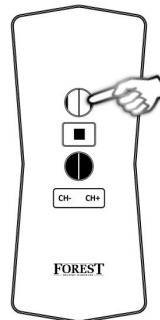

press STOP button when required height is reached. Press STOP button **5 times slowly for 1 seconds** to confirm

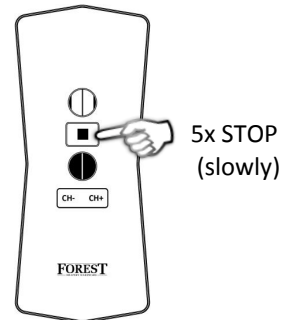

motor will turn to acknowledge

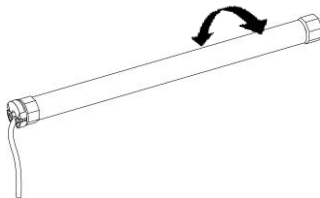

adjust to LOWER position

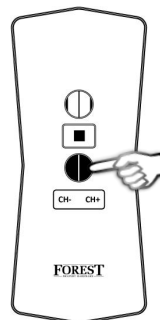

press STOP button when required height is reached. Press STOP button **5 times slowly for 1 seconds** to confirm

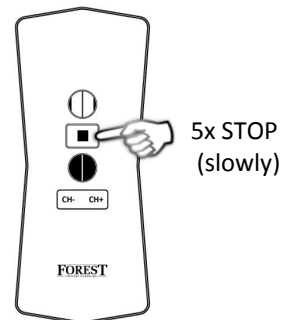

motor will turn to acknowledge, limits have been set successfully.

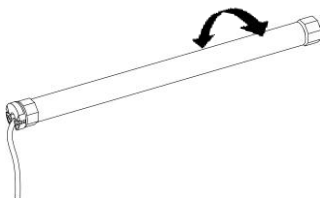

CANCELLATION OF UPPER AND LOWER END LIMITS:

 **IMPORTANT:** When cancelling end limits, the limits of all motors, programmed to selected channel, will be cancelled

press P button one time

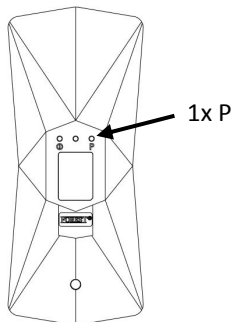

press CLOSE button one time

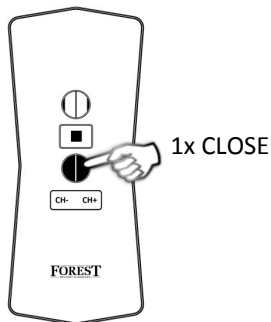

press P button one time

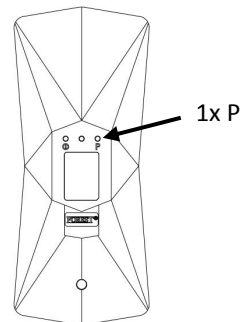

motor will turn to acknowledge

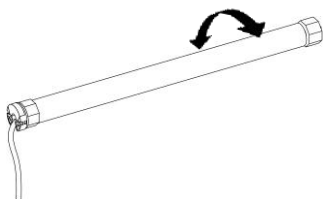

REVERSE DIRECTION SETTING:

When motor is not running, press button on motor for ~ 7 seconds, until motor turns to acknowledge.

TECHNICAL SPECIFICATION:

- 24Vdc, 16Watt
- nom. 0.8Nm – max. 1.0Nm
- 34 rpm
- max. running time 7 min.
- max. curtain weight 4 kg
- max. 5 cord rolls
- has to be used with Diamond remote, Multi remote and/or Multi wall switch RF
- only to be used in Forest BS system and with Forest power supply for BS motor



IMPORTANT: WHEN USING THE QUICK LOCK CORD ROLL, BE SURE TO LOCK THE CORD BEFORE USING THE MOTOR

PROGRAMMING WALL SWITCH TO BS MOTOR:

switch on power to the motor:



motor will jog to acknowledge:

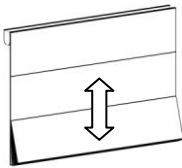

within 10 seconds after jog, select channel and press OPEN button

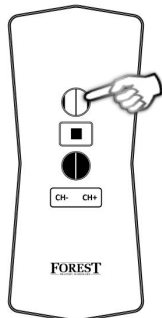

motor will jog to acknowledge:

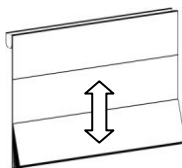

REMOVE PROGRAMMED CHANNEL

switch on power to the motor:



motor will jog to acknowledge:

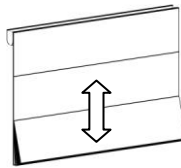

within 10 seconds after jog, select (to be removed) channel and press STOP button

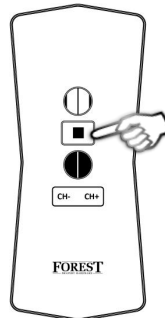

motor will jog to acknowledge:

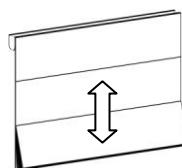

CHANGE MOTOR DIRECTION

switch on power to the motor:



motor will jog to acknowledge:

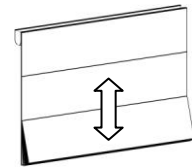

within 10 seconds after jog, select programmed channel and press CLOSE button

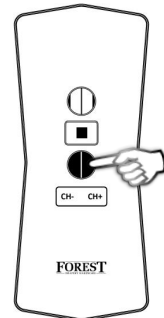

motor will jog to acknowledge:

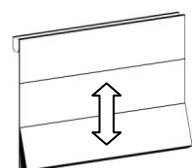

NOTE: if you need to start over, switch off the power and wait at least 20 seconds before switching in the power

SET UPPER END LIMIT

press P button once,
motor will jog to acknowledge:

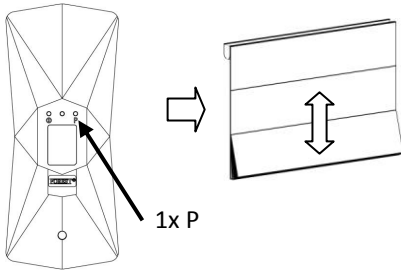

press OPEN button once,
motor will jog to acknowledge:

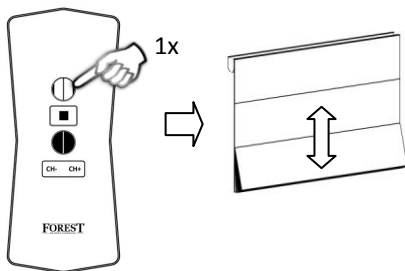

press P button once,
motor will jog to acknowledge:

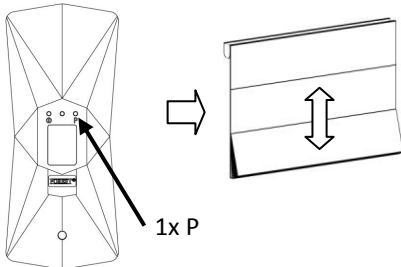

adjust desired upper end limit and
press P to save the upper limit:

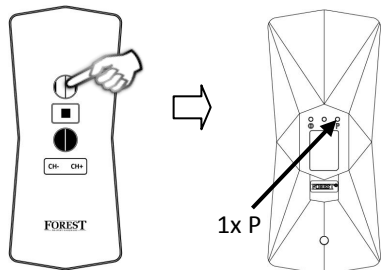

motor will jog to acknowledge:

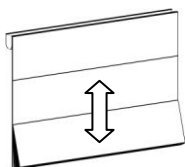

SET LOWER END LIMIT

press P button once,
motor will jog to acknowledge:

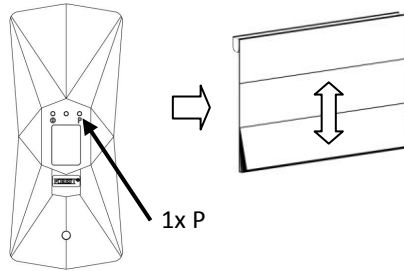

press CLOSE button once,
motor will jog to acknowledge:

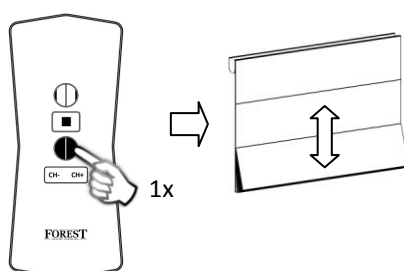

press P button once,
motor will jog to acknowledge:

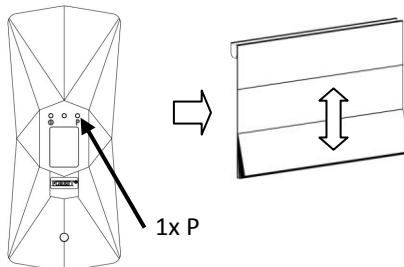

adjust desired lower end limit and
press P to save the lower limit

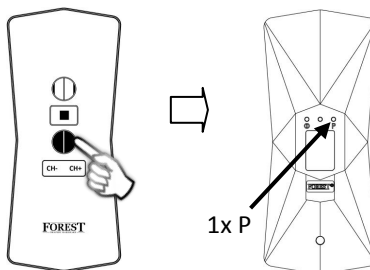

motor will jog to acknowledge:

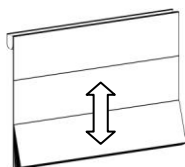

DELETE LIMITS

press P button twice,
motor will jog to acknowledge:

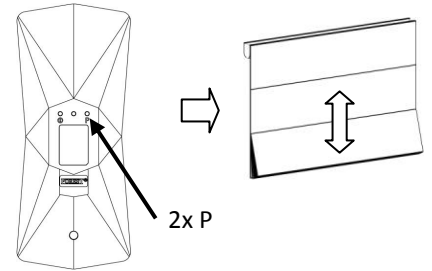

press OPEN button once,
motor will jog to acknowledge:

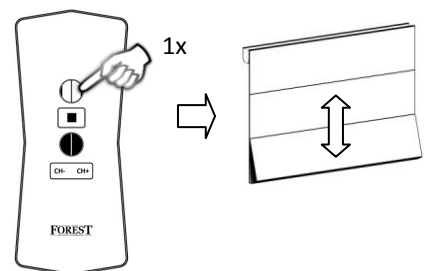

DELETE ALL MEMORY

press P button twice
motor will jog to acknowledge:

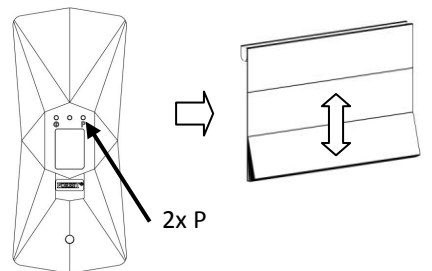

press CLOSE button on remote,
motor will jog twice to acknowledge

