

## FOREST CCS Track

CCS Cord Control System Track



THE WORLD  
BEHIND  
YOUR  
DRAPERIES





Scan for more information on the FOREST CCS Contract Cord System

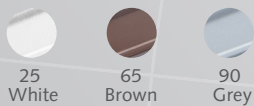

## CCS® CONTRACT CORD SYSTEM









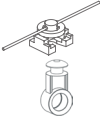

- Aluminum extrusion, powder coated and lubricated with a patented process.
- Maximum weight is 50 lbs per system.
- Bendable – CCS Track can be bent and curved. An exact size template is required.
- Cord draw, one or two way. Bead chain also available.
- Stackback: Ripplefold - 6" per width, pinchpleat - 7" per width, accordiafold - 5" per width.
- All Forest corded products include a child safety tension device and warning label.

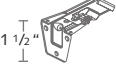
### ASSEMBLED SYSTEM

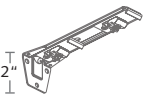
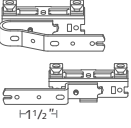
Includes track, masters, pinchpleat or ripplefold carriers, brackets, cord, tension pulley, child safety device.

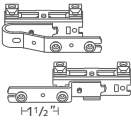
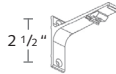
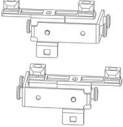
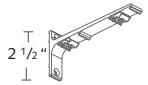
CCS	COMPONENT
•	 <p>CCS Contract Cord Track 20 tracks/bundle <b>51116-25</b> white 16' <b>51116-65</b> brown 16' <b>51116-90</b> grey 16'</p>
•	 <p><b>3906-25</b> <b>65</b> brown, <b>90</b> grey Track Connector</p>
•	 <p><b>52801-25</b> <b>65</b> brown, <b>90</b> grey End Pulley, 2 1/4" Reversible Use on right or left</p>

CCS	COMPONENT
•	 <p><b>52801-25A</b> Right <b>52801-25B</b> Left End Pulley w/ Snap 2 1/4 Reversible, for Ripplefold</p>
•	 <p><b>52803-25</b> <b>65</b> brown, <b>90</b> grey Small End Pulley 1 1/2" Reversible, use with Butt Masters and one-way draw</p>
•	 <p><b>3001-25</b> <b>65</b> brown, <b>90</b> grey Regular Duty Ceiling Bracket</p>

CCS	COMPONENT	CCS	COMPONENT
●	 <p><b>3003-25</b> 65 brown, 90 grey Heavy Duty Ceiling Bracket w/ Smart Klick</p>	●	 <p>Two Piece Connected Snap Carrier w/ Square Base, in plastic sleeve. Use 1 1/4" snap tape <b>2114-25</b> 60% fullness, 2 5/8" OC <b>2111-25, 65 brown, 90 grey</b> 80% fullness, 2 3/8" OC <b>2112-25</b> 100% fullness, 2 1/8" OC <b>2115-25</b> 120% fullness, 1 7/8" OC</p>
●	 <p><b>30031-25</b> 65 brown, 90 grey Ceiling Bracket Cover use with 3003-XX</p>	●	 <p><b>52008-25</b> 65 brown Slim Line Klick Carrier draperies hang to conceal track</p>
●	 <p><b>53202-25</b> 65 brown, 90 grey 3" Smart Klick Wall Bracket w/ wide base, adjusts 3-4.5"</p>	●	 <p><b>52004-25</b> Low Profile Ball Bearing</p>
●	 <p><b>53206-25</b> 65 brown, 90 grey 6" Smart Klick Double Wall Bracket w/ wide base adjusts 2.5"-4" &amp; 6"-7.5"</p>	●	 <p><b>52508-25</b> Overlap R <b>52509-25</b> Underlap L 65 brown Swivel Foot Multi-Functional Master for bends and curves</p>
●	 <p><b>3280-25</b> 65 brown, 90 grey 3" Wall Bracket, heavy duty projection 2 1/2"</p>	●	 <p><b>52508-25A</b> Overlap R <b>52509-25A</b> Underlap L 65 brown Swivel Foot Multi-Functional Master w/ snaps</p>
●	 <p><b>3285-25</b> 90 grey 4" Wall Bracket, heavy duty projection 3 1/2"</p>	●	 <p><b>52410-25</b> Butt R <b>52409-25</b> Butt L Standard Butt Master w/ snaps for baton use</p>
●	 <p><b>3281-25</b> 65 brown, 90 grey 6" Double Wall Bracket, heavy duty projection 1 1/2", 5 1/2"</p>	●	 <p><b>52510-25</b> 65 brown Cord Connector</p>
●	 <p><b>32801-25</b> 90 grey Wall Bracket Cover use with 3280, 3285 &amp; 3281</p>	●	 <p><b>9004-25</b> 3.2mm Cord 333.34 yds./roll</p>
		●	 <p><b>49502-00</b> Tension Device for child safety</p>

● Standard item in assembled sets.

# FOREST CCS® SPECIFICATIONS



## PRODUCT INFORMATION

- Heavy duty cord operated system, with separate internal cord channels; preventing cord sag and eliminating cord tangle.
- Quick installation with "Smart Klick". brackets for wall and ceiling applications.
- Bendable; it can be curved and reversed curved with a 8" radius or continuous curve.
- Heavy duty clickable carriers - 10 carriers on a breakaway strip - UV protected.
- Can also be used for Forest Easyfold and accordiafold drapery systems.
- Maximum fabric weight is 50 lbs. per system.
- Track finish: chromated powder coating with a factory applied patented dry lubricant.
- Warranty: 10 years.



Easy installation  
click - position - tighten



Clickable carrier

## PROFILE

- Shown actual size 1:1
- Aluminum Extrusion
- Weight: 3.22 ounce per ft
- Dimensions: 3/4" x 3/4"

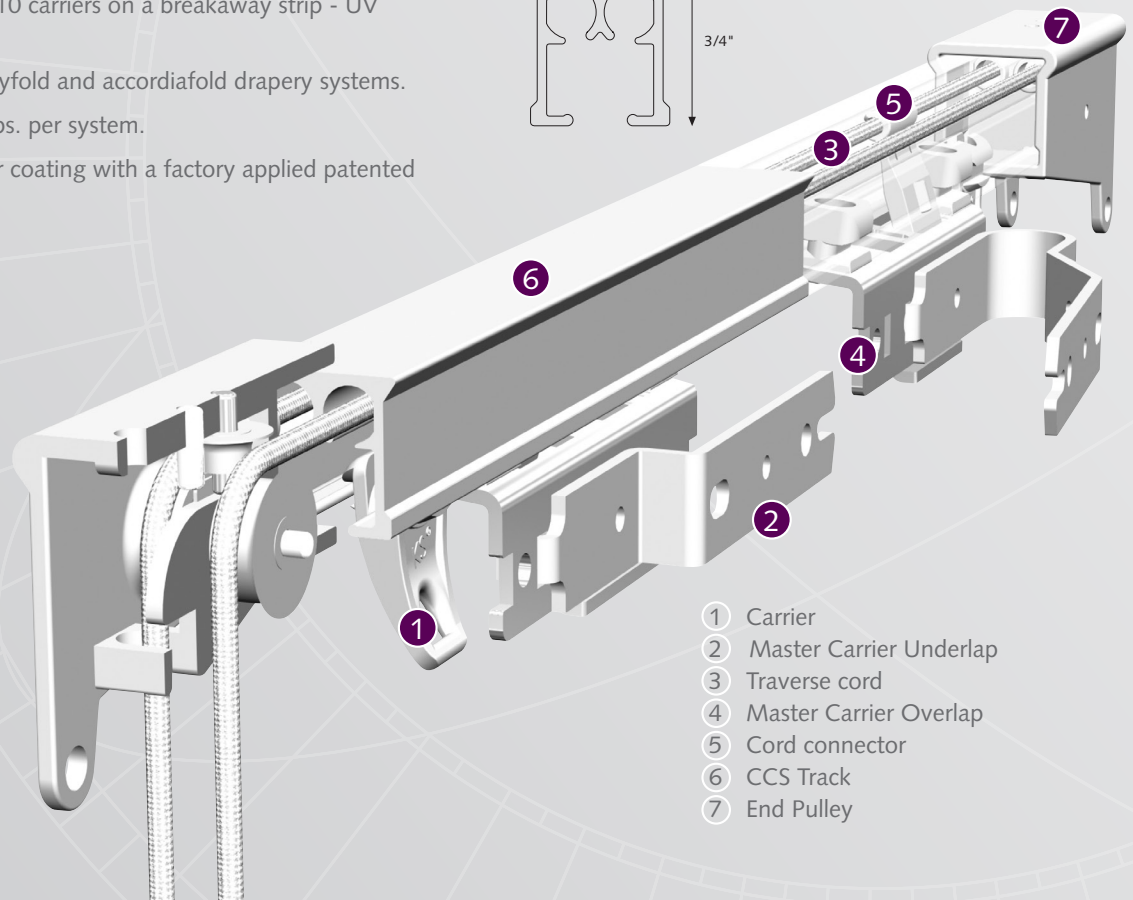
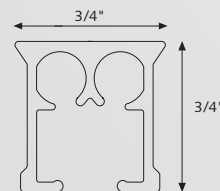

- 1 Carrier
- 2 Master Carrier Underlap
- 3 Traverse cord
- 4 Master Carrier Overlap
- 5 Cord connector
- 6 CCS Track
- 7 End Pulley





### Smart Klick Ceiling Bracket with cover

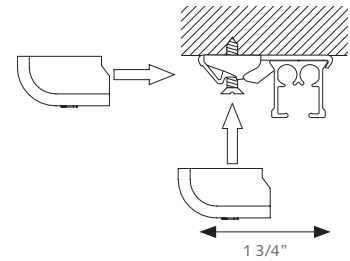

### Smart Klick Single Wall Bracket

- A) 3"                      B) 2 1/2"
- A) 4"                      B) 3 1/2"

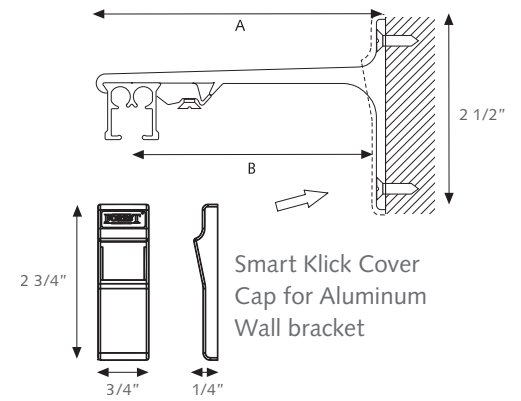

### Smart Klick Wall Double Wall Bracket

- A) 6"                      B) 3 1/2"                      C) 1 3/4"

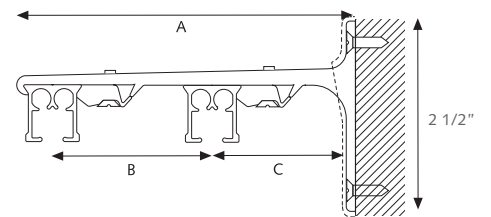

Brackets need to be placed every 36", depending on fabric weight.

## APPLICATIONS

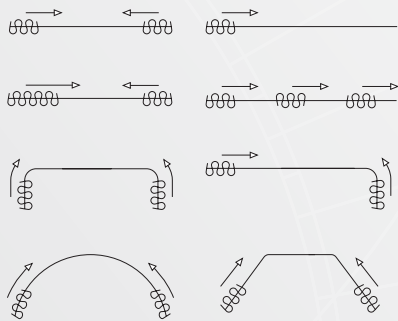

## BENDING / CURVING

The track can be curved and reversed curved using an 8" radius. Continuous curving can be done with the electric powered bender.



## FOR USE IN

Hotels - motels - offices - healthcare - schools - residential or any location where a cord operated system is required.