

DEVENTER CRS® TRAVERSING COLLECTION INSTALL INSTRUCTIONS

YOU HAVE RECEIVED A PRE-ASSEMBLED SYSTEM. BY SIMPLY FOLLOWING THESE STEP-BY-STEP INSTRUCTIONS, YOU WILL SOON BE ENJOYING YOUR NEW DRAPERY HARDWARE.

Getting Started:

Please read through all instructions carefully before you begin.

Unpack all materials making sure all components are included:

- Screws
- Rails built to your specifications
- Mounting bracket and backplate
- Allen keys
- Finials
- Splice (optional)

Tools You Will Need:

- Drill with a 1/8" bit and a Phillips bit
- Phillips screwdriver
- Metal tape measure

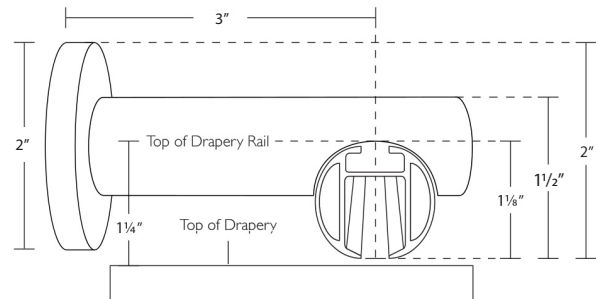

Installing Your Wall Mount Drapery Hardware:

Please read through all instructions carefully before you begin.

1. Mark

Mark the height you would like the top of the top of your drapery rail to be installed, taking into account any clearance or puddling you desire at the bottom, as well as top of rail to top of drapery difference - 1 1/4".

2. Mount

Measure the width of the track. Mark the placement of the two end brackets at the height determined in step 1, approximately 3"-4" in from the ends of where the track will be installed.

Take the back plate off the bracket and place the center of the back plate at marked height. (Remove the back plate from bracket by rotating plate counter clockwise).

NOTE: The top of bracket will rise 1" above the rail.

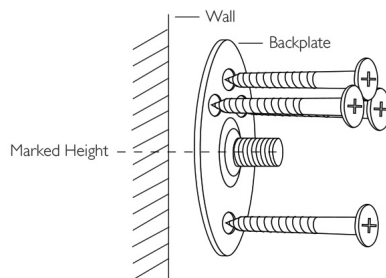

3. Assemble Bracket

Reassemble the bracket onto the back plate. Screw bracket clockwise onto back plate. Turn until tight. Make sure bracket is facing down (loosen bracket set screw to adjust and tighten once complete).

4. Attach Rail to Bracket

Make sure rail holding set is attached to the bracket loosely (you should receive it this way).

Attach the rail to the brackets making sure holding rail set slips into top channel.

Lock the rail holding set into the top channel using included Allen key.

5. Attach Finials

Attach finials to both ends of the rail.

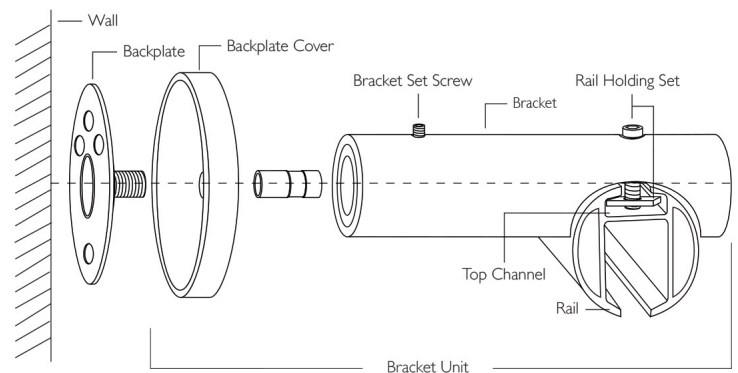

DEVENTER CRS® TRAVERSING COLLECTION INSTALL INSTRUCTIONS (continued)

PLEASE SEE ADDITIONAL BRACKET OPTIONS BELOW. FOLLOW SAME INSTALLATION INSTRUCTIONS AS ON THE PREVIOUS PAGE AND TAKING MEASUREMENTS INTO ACCOUNT.

Installing Your Wall Mount Drapery Hardware:

Deventer Single Wall Bracket
53401-XX

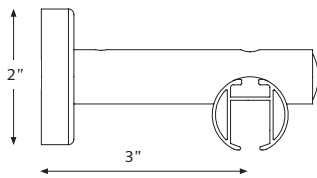

Deventer Double Wall Bracket
53406-XX

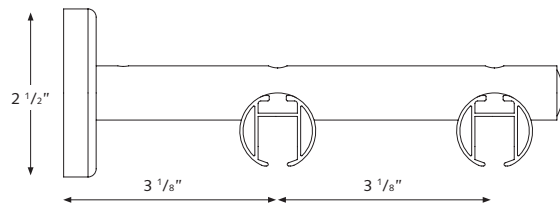

Deventer Extended Single Wall Bracket
53402-XX

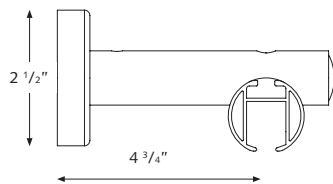

Deventer Extended Double Wall Bracket
53407-XX

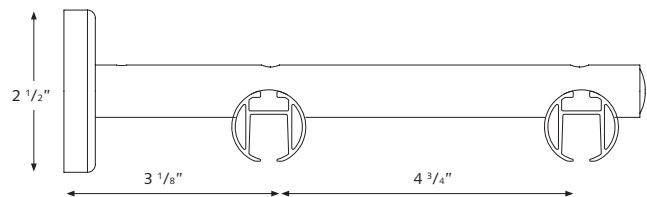

Installing a Splice on your Track System:

Please read through all instructions carefully before you begin.

1. Insert the Track Splice into the top channel of one of the tracks.
2. Tighten 2 set screws securely with included Allen Key.
3. Once both tracks have been attached to mounting brackets, butt the two tracks up against one another and ensure they line up seamlessly. Make sure the "arm(s)" of the master carrier(s) are facing into the room.
4. Tighten the other 2 set screws on the Track Splice.

