



**MANUAL**  
OPERATION



**EASY**  
TO BEND

## FOREST KS® Track

KS® Klick System Track with "Smart Klick" brackets easy install brackets

FOREST KS® Klick System Track  
FOREST Batons

THE WORLD  
BEHIND  
YOUR  
DRAPERIES

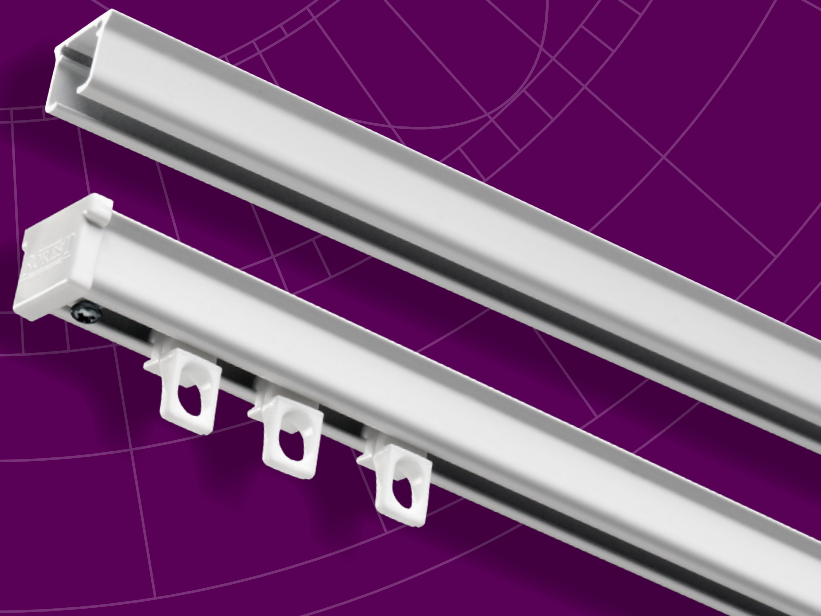

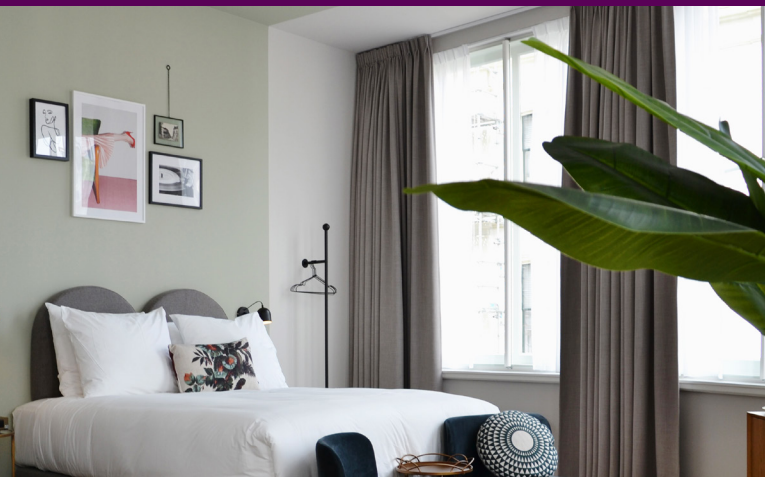

Scan for more information on the FOREST Track Systems



25  
White

59  
Black

65  
Brown

90  
Grey

## KS® KLICK SYSTEM

- Aluminum extrusion, powder coated and lubricated with a patented process.
- Maximum weight is 3 lbs/ft.
- Bendable – KS trackscan be bent and curved. An exact size template is required.
- Hand or baton draw, one or two way.
- Stackback: ripplefold - 6" per width, pinchpleat - 7" per width, cubicle - 5" per width, accordiafold - 5" per width.

### ASSEMBLED SYSTEM

Includes track, masters, pinchpleat or ripplefold carriers, brackets, and 36" white fiberglass baton

### BATON OPTIONS



White fiberglass batons are available in 36", 48", 60", and 72" lengths. See all baton options, including the finishes below, at the end of brochure.





25  
White

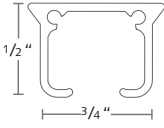
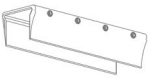

59  
Black

81  
Bronze









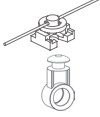

90  
Grey

KS	COMPONENT
•	 <p>KS Klick System Track  <b>1013-25</b> white 13' 1"  <b>1016-25</b> white 16' 4"  <b>1019-25</b> white 19' 8"    <b>1016-59</b> black 16' 4"  <b>1016-65</b> brown 16' 4"  <b>1016-90</b> grey 16' 4"</p>
•	 <p><b>3903-25</b>  <b>59</b> black, <b>65</b> brown,  <b>90</b> grey                      Track Connector, key <b>3904-00</b></p>
•	 <p><b>2309-25</b>  <b>59</b> black, <b>65</b> brown, <b>90</b> grey                      KS End Cap Multifunctional</p>

KS	COMPONENT
•	 <p><b>2309-25S</b>  <b>59S</b> black, <b>90S</b> grey                      KS End Cap Short                      reduces light gap</p>
•	 <p><b>9100-00</b>                      Channel Protector</p>
•	 <p><b>3001-25</b>  <b>59</b> black, <b>65</b> brown, <b>90</b> grey Regular Duty                      Ceiling Bracket</p>
•	 <p><b>3901-25</b>  <b>59</b> black, <b>90</b> grey                      Ceiling Splice/Bracket</p>

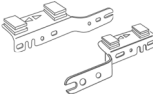
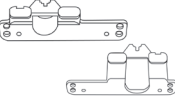
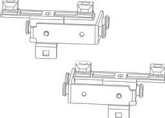
KS	COMPONENT
●	 <p><b>3003-25</b> 59 black, 65 brown, 90 grey Heavy Duty Ceiling Bracket w/ Smart Klick</p>
●	 <p><b>30031-25</b> 59 black, 65 brown, 90 grey Ceiling Bracket Cover use with 3003-XX</p>
●	 <p><b>53202-25</b> 59 black, 65 brown, 90 grey 3" Smart Klick Wall Bracket w/ wide base, adjusts 3-4.5"</p>
●	 <p><b>53206-25</b> 59 black, 65 brown, 90 grey 6" Smart Klick Double Wall Bracket w/ wide base, adjusts 2.5"-4" &amp; 6"-7.5"</p>
●	 <p><b>3280-25</b> 59 black, 65 brown, 90 grey 3" Wall Bracket, heavy duty projection 2 1/2"</p>
●	 <p><b>3285-25</b> 59 black, 90 grey 4" Wall Bracket, heavy duty projection 3 1/2"</p>
●	 <p><b>3281-25</b> 59 black, 65 brown, 90 grey 6" Double Wall Bracket, heavy duty projection 1 1/2", 5 1/2"</p>
●	 <p><b>32801-25</b> 59 black, 90 grey Wall Bracket Cover use with 3280, 3285 &amp; 3281</p>
●	 <p><b>2001-25</b> 59 black, 65 brown, 90 grey Klick Carrier, for pinch pleat</p>
●	 <p><b>2002-25</b> 59 black, 65 brown, 90 grey Shirrtape Carrier</p>
●	 <p><b>2004-25</b> 59 black Snap Carrier, for accordiafold</p>

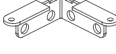
● Standard item in assembled sets.

KS	COMPONENT
●	 <p>Two Piece Connected Snap Carrier w/ Square Base Use 1 1/4" snap tape <b>2114-25, 59</b> black 60% fullness, 2 5/8" OC <b>2111-25, 65</b> brown, <b>90</b> grey 80% fullness, 2 3/8" OC <b>2112-25, 59</b> black 100% fullness, 2 1/8" OC <b>2115-25, 59</b> black 120% fullness, 1 7/8" OC</p>
●	 <p><b>52003-25</b> 65 brown Economy Slide</p>
●	 <p><b>52004-25</b> Low Profile Ball Bearing Carrier</p>
●	 <p><b>2201-25</b> 59 black Klick Carrier w/ Stainless Hook Use with grommets</p> <p>1 3/4" from top of track to bottom of J hook.</p>
●	 <p><b>52005-25</b> Button Slide Carrier</p>
●	 <p><b>52105-25</b> Button Slide Carrier w/ Hook</p>
●	 <p><b>2525-25</b> Overlap R <b>2526-25</b> Underlap L <b>65</b> brown Pinchpleat Master <b>2527-25</b> Overlap L <b>2528-25</b> Underlap R</p>
●	 <p><b>B8809-23-00</b> Overlap R <b>B8809-24-00</b> Underlap L 59 black Plastic Snap Master</p>
●	 <p><b>52410-25</b> Butt R <b>52409-25</b> Butt L 59 black Standard Butt Master w/ snaps and for baton use</p>
●	 <p><b>2305-25</b> 59 black, 65 brown, 90 grey Twist On End Stop</p>
●	 <p><b>52307-90</b> End Lock</p>
●	 <p><b>2308-25</b> Return Plate reversible, 2 1/2" return</p>
●	 <p><b>54110-25</b> 36" Fiberglass Baton w/ snap. See all batons at the end of brochure.</p>

# FOREST KS® SPECIFICATIONS



## PRODUCT INFORMATION

- Highly efficient hand drawn system for all types of light to medium weight draperies.
- Quick installation with “Smart Klick” brackets for wall and ceiling applications plus optional cover caps that conceal the screws.
- Bendable - KS can be curved and reversed curved using a 4” radius or continuous curve.
- Suitable for special window shapes such as circular, arched and triangular.
- Heavy duty clickable carriers are UV-protected and offer smooth, easy traversing. Shape is offset so pleats hang straight.
- Can also be used with ripplefold and accordiafold drapery.
- Maximum fabric weight: 3 lbs per foot.
- Finish colors available: white, black, brown, and silver.
- Available lengths: 13’1” , 16’4” , and 19’8” .
- Track finish: chromated powder coating with a factory applied patented dry lubricant.

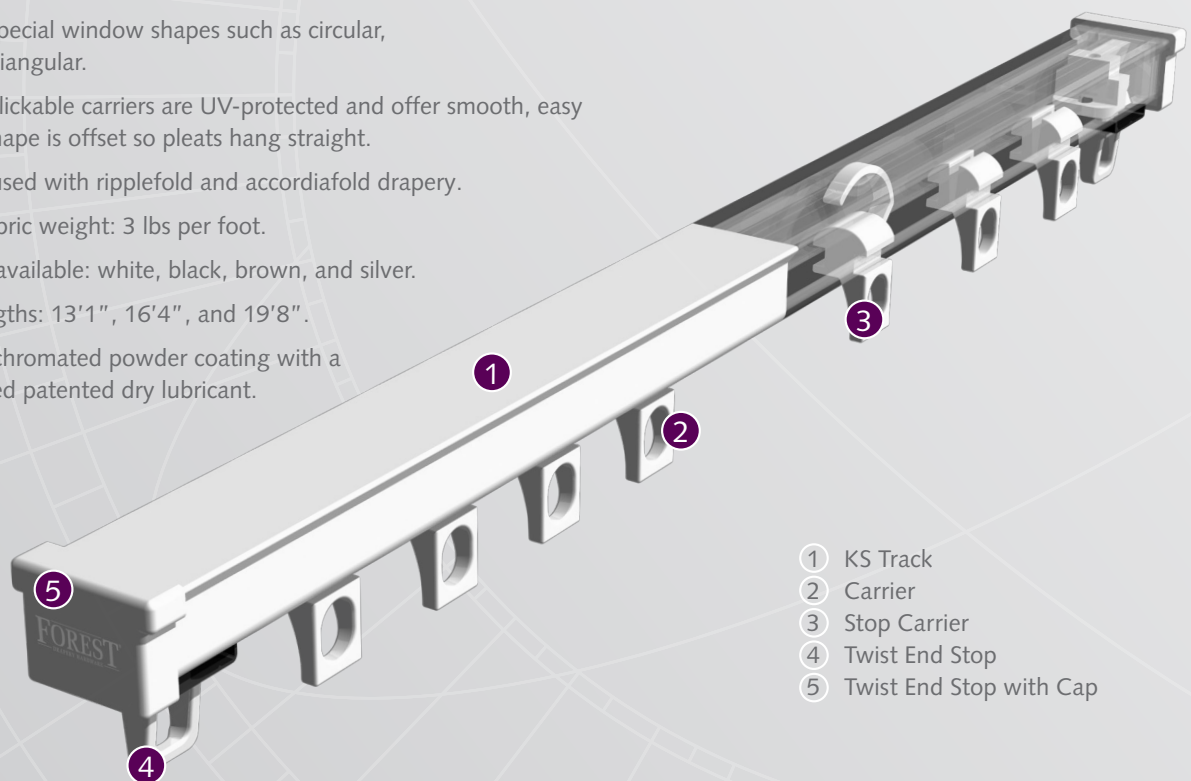



## PROFILE

- Weight: 1.62 ounce per ft.
- Aluminum Extrusion
- Dimensions: 3/4" x 1/2"

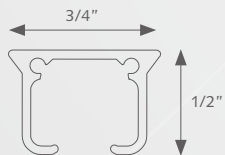

## FOR USE IN

Hotels, offices, schools, healthcare, residences, boats, campers, planes or at any location where an efficient hand drawn system is required.

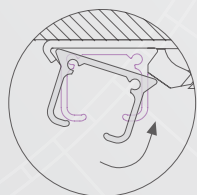

Easy installation  
click - position - tighten

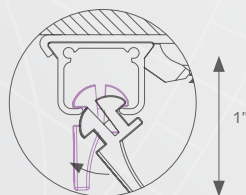

clickable carrier

## BENDING / CURVING

The track can be curved and reversed curved using a 6" or 8" radius. Continuous curving is also possible with the electrical bending tool. Actual size template is required.

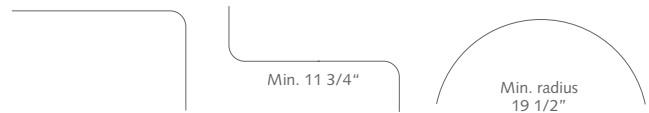

## APPLICATIONS

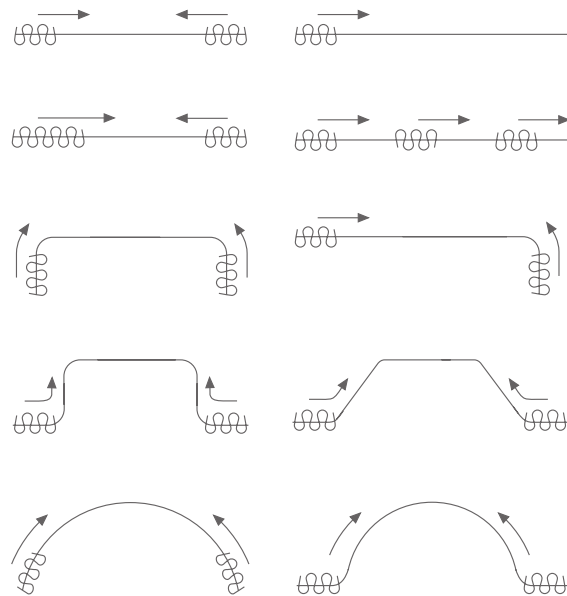

## MOUNTING BRACKETS

Brackets need to be placed every 36".

### Heavy Duty Ceiling Bracket with Smart Klick 3003-XX

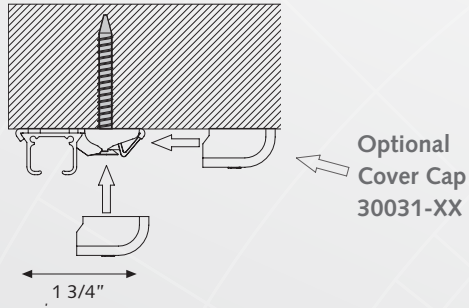

### 3" Smart Klick Wall Bracket 53202-XX

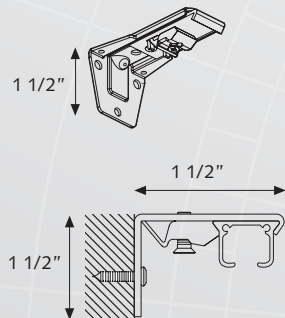

### 6" Smart Klick Double Wall Bracket 53206-XX

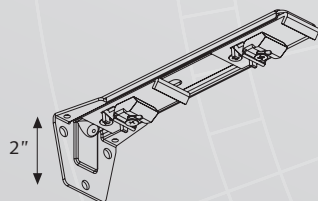

### 3" Single Wall Bracket 3280-XX

A) 3" B) 2 1/2"

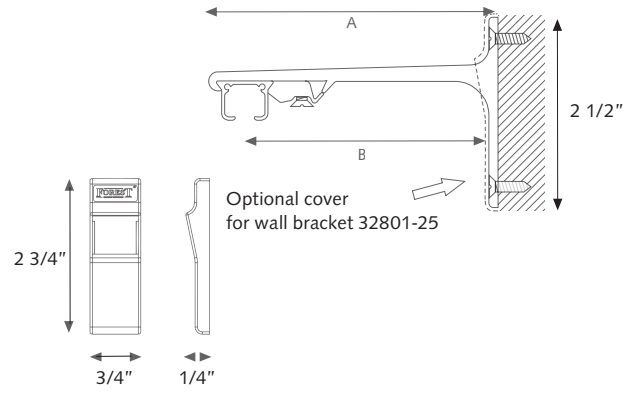





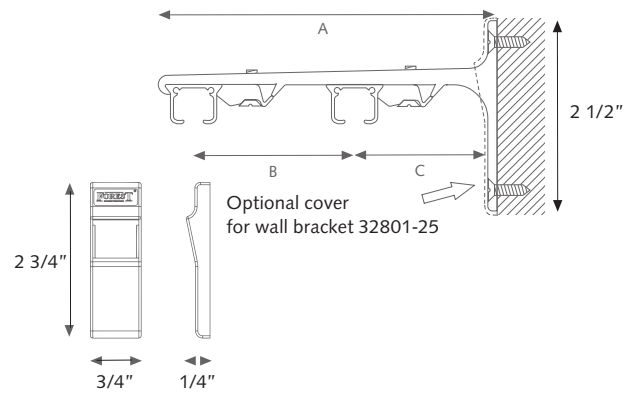







### 6" Double Wall Bracket 3281-XX

A) 6" B) 3 5/8" C) 1 3/4"









# FOREST BATONS

## FIBERGLASS, ACRYLIC, ADA & COMPONENTS

BATONS	COMPONENT	BATONS	COMPONENT	
 	<b>3/8" Fiberglass Baton</b> Must order screw separately  <b>36"</b> 54110-25 white w/ snap 54310-25 white w/ adaptor  <b>54110-59, 81, 90</b> w/ snap  <b>48"</b> 54111-25 white w/ snap 54311-25 white w/ adaptor  <b>54111-59, 81, 90</b> w/ snap  <b>60"</b> 54112-25 white w/ snap 54312-25 white w/ adaptor  <b>54112-59, 81, 90</b> w/ snap  <b>72"</b> 54113-25 white w/ snap 54313-25 white w/ adaptor  <b>54113-59, 81, 90</b> w/ snap  <b>84"</b> 54114-25 white w/ snap  <b>96"</b> 54115-25 white w/ snap	 	<b>1/2" Clear Acrylic Baton</b> Must order screw separately  <b>36"</b> 54510-00 w/ snap 54710-00 w/ adaptor  <b>48"</b> 54511-00 w/ snap 54711-00 w/ adaptor  <b>60"</b> 54512-00 w/ snap 54712-00 w/ adaptor  <b>72"</b> 54513-00 w/ snap 54713-00 w/ adaptor	
	<b>Colors available for 3/8" Fiberglass Batons</b>   25 White  59 Black  81 Bronze  90 Grey			<b>ADA Clear Acrylic Baton</b>  <b>48"</b> 54911-00 w/ adaptor
				<b>9013-00</b> Baton Holder, clear acrylic
				<b>54001-16</b> Baton Snap
				<b>9015-00</b> Hex Head Shoulder Screw for baton w/ adaptor
				<b>54000-16</b> D-Ring

## DECORATIVE METAL & WOOD

 <p><b>29MWAND-XX</b> 40" Metal Baton</p>	 <p><b>29AWAND-16</b> 40" Round Metal Baton Stainless Steel</p>	 <p><b>29SWAND-16</b> 40" Square Metal Baton Stainless Steel</p>	 <p><b>29IWAND-XX</b> 40" Wrought Iron Baton</p>	 <p><b>19WWAND-XX</b> 40" Wood Baton</p>	 <p><b>19CWAND-XX</b> 40" Modern Baton</p>
---	--	---	---	--	---