



CUSTOM BEND & CURVE TRACKS AND H-RAIL

- Forest will custom bend and curve our hardware to your exact specifications. Or, bend and curve at your workroom with our equipment.
- All bend and curve orders require a template at actual size. Mail your template to Forest Drapery Hardware, 2500 Donn Drive, Cartersville GA 30120, Attn: Inside Sales.



CS TRACK



CCS TRACK



KS TRACK

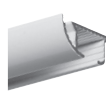

DS TRACK

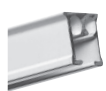

FMS TRACK



DRESDEN TRAVERSE & MOTORIZED
Polished chrome and wood foil
cannot be bent or curved



DEVENTER CRS & MRS

KS/DS BENDER



Scan for a video showing how to set up the KS/DS Bender

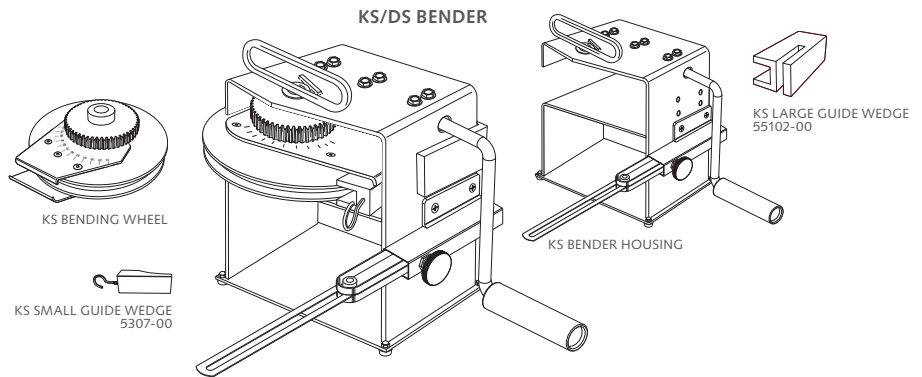

KS & DS	COMPONENT
	KS/DS Housing Unit 5001-00
	Bending Strips 5302-00 KS 5312-00 DS
	Bending Wheel Sets Includes wheel, wedges, and bending strips. 55401-00 KS 55402-00 DS

KS & DS	COMPONENT
	Small Guide Wedge 5307-00 KS (pictured) 5308-00 DS white 5309-00 DS grey Both DS wedges are required.
	Large Guide Wedge 55102-00 KS (pictured) 55103-00 DS white 55104-00 DS grey Both DS wedges are required.





BENDING & CURVING



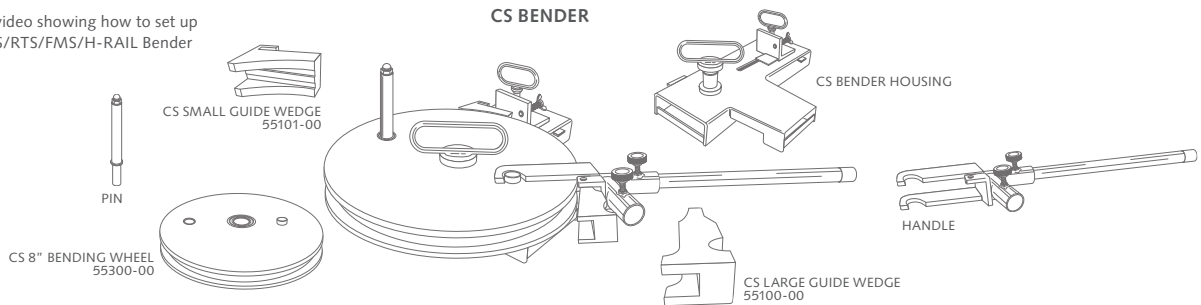

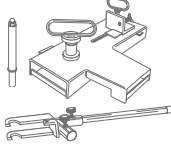
CS/CCS/FMS/H-RAIL BENDER



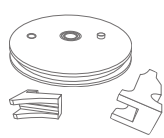

Scan for a video showing how to set up the CS/CCS/RTS/FMS/H-RAIL Bender

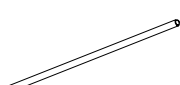



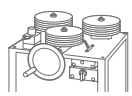

CS, CCS, FMS, H-RAIL	COMPONENT
<ul style="list-style-type: none">  	<ul style="list-style-type: none"> CS/CCS/FMS/H-RAIL Housing Unit with handle & pin 55002-00
<ul style="list-style-type: none">  	<ul style="list-style-type: none"> CS Bending Strip 55302-00
<ul style="list-style-type: none">  	<ul style="list-style-type: none"> CCS Bending Strip 55303-00
<ul style="list-style-type: none">  	<ul style="list-style-type: none"> FMS Bending Strip 55306-00
<ul style="list-style-type: none">  	<ul style="list-style-type: none"> H-Rail Bending Strip 55314-00

CS, CCS, FMS, H-RAIL	COMPONENT
<ul style="list-style-type: none">  	<ul style="list-style-type: none"> Bending Wheels w/ wedges 55300-00 CS/CCS/FMS 55310-00 H-Rail
<ul style="list-style-type: none">  	<ul style="list-style-type: none"> Small Guide Wedge 55101-00 CS/CCS/FMS 55315-00 H-Rail
<ul style="list-style-type: none">  	<ul style="list-style-type: none"> Large Guide Wedge 55100-00 CS/CCS/FMS 55316-00 H-Rail
<ul style="list-style-type: none">  	<ul style="list-style-type: none"> Extension Arm for handle 55317-00
<ul style="list-style-type: none">  	<ul style="list-style-type: none"> Stand for CS Bender 55318-00

KS/DS/CS/CCS/FMS/H-RAIL CURVING

CURVING	COMPONENT
<ul style="list-style-type: none">  	<ul style="list-style-type: none"> Electronic Continuous Curver 110 Volt curver for accurate and high output curving. Wheels not included. 5004-00
<ul style="list-style-type: none">  	<ul style="list-style-type: none"> Curving Wheels, set of 3 5304-00 KS 5306-00 DS 5305-00 CS/CCS/FMS 55311-00 H-Rail

CURVING	COMPONENT
<ul style="list-style-type: none">  	<ul style="list-style-type: none"> KS Curving Strip, 23' 55308-00
<ul style="list-style-type: none">  	<ul style="list-style-type: none"> DS/CCS Curving Strip, 23' 55304-00
<ul style="list-style-type: none">  	<ul style="list-style-type: none"> CS/FMS Curving Strip, 23' 55307-00
<ul style="list-style-type: none">  	<ul style="list-style-type: none"> H-Rail Curving Strip, 23' 55313-00