



MANUAL
OPERATION



EASY
TO BEND

FOREST DS® Track

DS® Design System Track with an elegant profile

FOREST DS® Design System Track
FOREST Batons

THE WORLD
BEHIND
YOUR
DRAPERIES





Scan for more information on the FOREST Track Systems

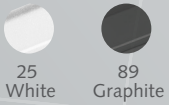
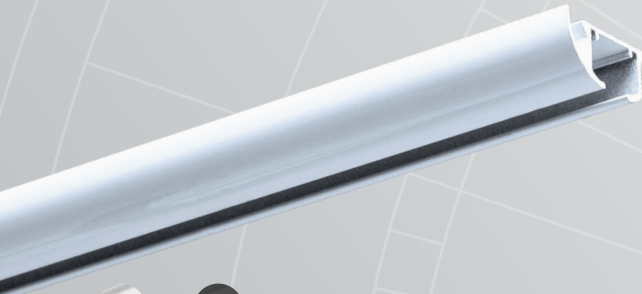

DS® DESIGN SYSTEM

- Aluminum extrusion, powder coated and lubricated with a patented process.
- Maximum weight is 3 lbs/ft.
- DS tracks can be bent and curved. An exact size template is required.
- Hand or baton draw, one or two way.
- Stackback: ripplefold - 6" per width, pinchpleat - 7" per width, cubicle - 5" per width, accordiafold - 5" per width.



ASSEMBLED SET

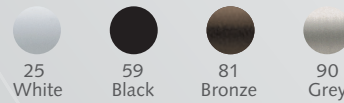

Includes track, masters, pinchpleat or ripplefold carriers, brackets, and 36" white fiberglass baton at the end of brochure.

BATON OPTIONS

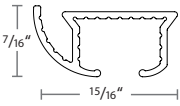
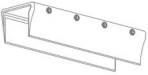













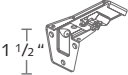

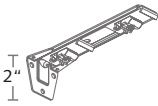
White fiberglass batons are available in 36", 48", 60", and 72" lengths. See all baton options, including the finishes below, at the end of brochure.

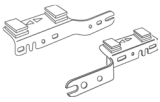

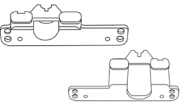
| DS | COMPONENT |
|----|---|
| • |  <p>DS Design System Track 1116-25 white 1116-89 graphite 16' 4"</p> |
| • |  <p>3903-25 59 black Track Connector + key 3904-00</p> |
| • |  <p>2309-25 59 blackKS End Cap Multifunctional</p> |

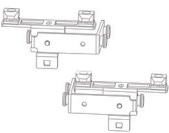
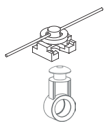
| DS | COMPONENT |
|----|--|
| • |  <p>9100-00 Channel Protector</p> |
| • |  <p>3001-25 59 black Regular Duty Ceiling Bracket</p> |
| • |  <p>3901-25 59 black Ceiling Splice/Bracket</p> |

FOREST DS®

| DS | COMPONENT | DS | COMPONENT |
|----|--|----|--|
| ● |  <p>3003-25 59 black Heavy Duty Ceiling Bracket w/ Smart Klick</p> | ● |  <p>52003-25 65 brown Economy Slide</p> |
| ● |  <p>30031-25 59 black Ceiling Bracket Cover use with 3003-XX</p> | ● |  <p>1 3/4" from top of track to bottom of J hook. 1 1/8"</p> <p>2201-25 59 black Klick Carrier w/ Stainless Hook Use with grommets</p> |
| ● |  <p>1 1/2"</p> <p>53202-25 59 black 3" Smart Klick Wall Bracket w/ wide base, adjusts 3-4.5"</p> | ● |  <p>52005-25 Button Slide Carrier</p> |
| ● |  <p>2"</p> <p>53206-25 59 black 6" Smart Klick Double Wall Bracket w/ wide base adjusts 2.5"-4" & 6"-7.5"</p> | ● |  <p>52105-25 Button Slide Carrier w/ Hook</p> |
| ● |  <p>2001-25 59 black Klick Carrier, for pinch pleat</p> | ● |  <p>2525-25 Overlap R 2526-25 Underlap L Pinchpleat Master 2527-25 Overlap L 2528-25 Underlap R</p> |
| ● |  <p>2002-25 59 black Shirrtape Carrier</p> | ● |  <p>B8809-23-00 Overlap R B8809-24-00 Underlap L 59 black Plastic Snap Master</p> |
| ● |  <p>2004-25 59 black Snap Carrier, for accordiafold</p> | ● |  <p>52410-25 Butt R 52409-25 Butt L 59 black Standard Butt Master w/ snaps and for baton use</p> |
| ● |  <p>Two Piece Connected Snap Carrier w/ Square Base, in plastic sleeve. Use 1 1/4" snap tape 2114-25, 59 black 60% fullness, 2 5/8" OC 2111-25, 65 brown, 90 grey 80% fullness, 2 3/8" OC 2112-25, 59 black 100% fullness, 2 1/8" OC 2115-25, 59 black 120% fullness, 1 7/8" OC</p> | ● |  <p>2305-25 59 black Twist On End Stop</p> |
| | | ● |  <p>52307-90 End Lock</p> |
| | | ● |  <p>2308-25 Return Plate reversible, 2 1/2" return</p> |
| | | ● |  <p>54110-25 36" Fiberglass Baton w/ snap See all batons at the end of document</p> |

● Standard item in assembled sets.

FOREST DS® SPECIFICATIONS



PRODUCT INFORMATION

- Elegant and aesthetically pleasing hand drawn system for all types of light to medium weight draperies.
- Quick installation with “Smart Klick” brackets for wall and ceiling applications.
- Hidden brackets are behind the elegant shape of the track.
- Heavy duty clickable carriers are UV protected and offer smooth, easy traversing.
- Can be used with pinchpleat, ripplefold and accordiafold draperies.
- Recommended maximum fabric weight is 3 lbs./ft.
- Track finish is a chromated powder coating with a factory applied patented dry lubricant.
- Limited lifetime warranty.

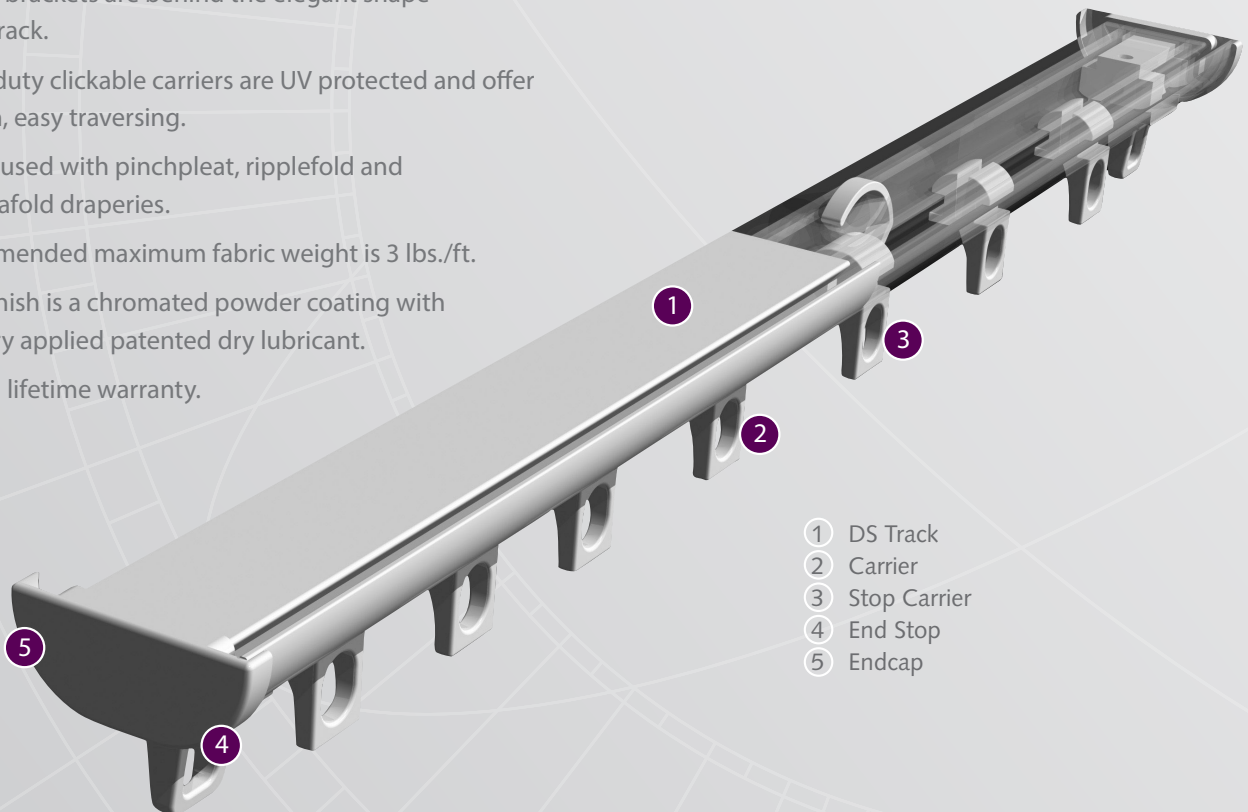

- 1 DS Track
- 2 Carrier
- 3 Stop Carrier
- 4 End Stop
- 5 Endcap



PROFILE

- Aluminum Extrusion
- Dimensions: 1 1/4" x 1/2"

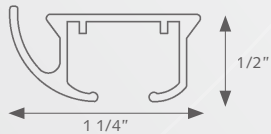

FOR USE IN

Hotels, motels, offices, schools, healthcare facilities, residences or at any location where an elegant hand drawn system is desired.

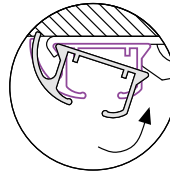

Easy installation
click - position - tighten

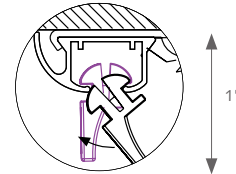

clickable carrier

APPLICATIONS

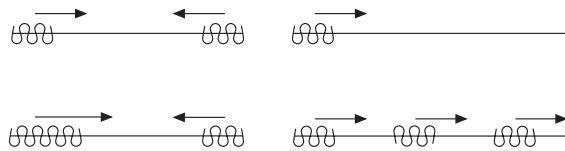

MOUNTING BRACKETS

Brackets need to be placed every 24".

Heavy Duty Ceiling Bracket with Smart Klick 3003-XX

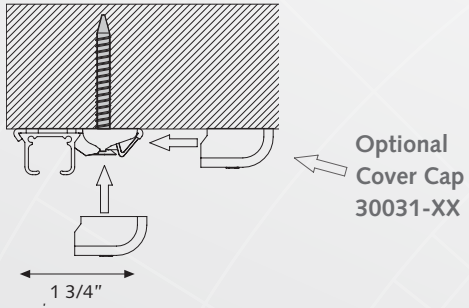

3" Smart Klick Wall Bracket 53202-XX

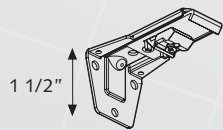



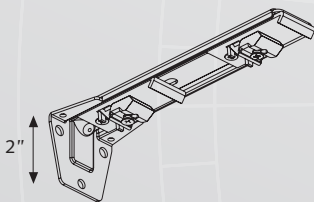









6" Smart Klick Double Wall Bracket 53206-XX



FOREST BATONS

FIBERGLASS, ACRYLIC, ADA & COMPONENTS

| BATONS | COMPONENT |
|--------|--|
| ● |  snap  adaptor 3/8" Fiberglass Baton Must order screw separately 36" 54110-25 white w/ snap 54310-25 white w/ adaptor 54110-59, 81, 90 w/ snap 48" 54111-25 white w/ snap 54311-25 white w/ adaptor 54111-59, 81, 90 w/ snap 60" 54112-25 white w/ snap 54312-25 white w/ adaptor 54112-59, 81, 90 w/ snap 72" 54113-25 white w/ snap 54313-25 white w/ adaptor 54113-59, 81, 90 w/ snap 84" 54114-25 white w/ snap 96" 54115-25 white w/ snap |
| | ● Colors available for 3/8" Fiberglass Batons  25 White  59 Black  81 Bronze  90 Grey |

| BATONS | COMPONENT |
|--------|---|
| ● |  snap  adaptor 1/2" Clear Acrylic Baton Must order screw separately 36" 54510-00 w/ snap 54710-00 w/ adaptor 48" 54511-00 w/ snap 54711-00 w/ adaptor 60" 54512-00 w/ snap 54712-00 w/ adaptor 72" 54513-00 w/ snap 54713-00 w/ adaptor |
| | ●  adaptor ADA Clear Acrylic Baton 48" 54911-00 w/ adaptor |
| ● |  9013-00 Baton Holder, clear acrylic |
| ● |  54001-16 Baton Snap |
| ● |  9015-00 Hex Head Shoulder Screw for baton w/ adaptor |
| ● |  54000-16 D-Ring |

BATONS DECORATIVE METAL & WOOD

