



CS[®] RECESS TRACKS



MANUAL
OPERATION

Forest tracks are installed in more than 100 countries worldwide. With a 10 year warranty, they are characterized by the strength of the extrusion, powder coated surface, and a patented dry lubricant.

CS[®] RECESSED TRACK SYSTEM

THE WORLD
BEHIND
YOUR
DRAPERIES



FOREST CS[®] RECESS

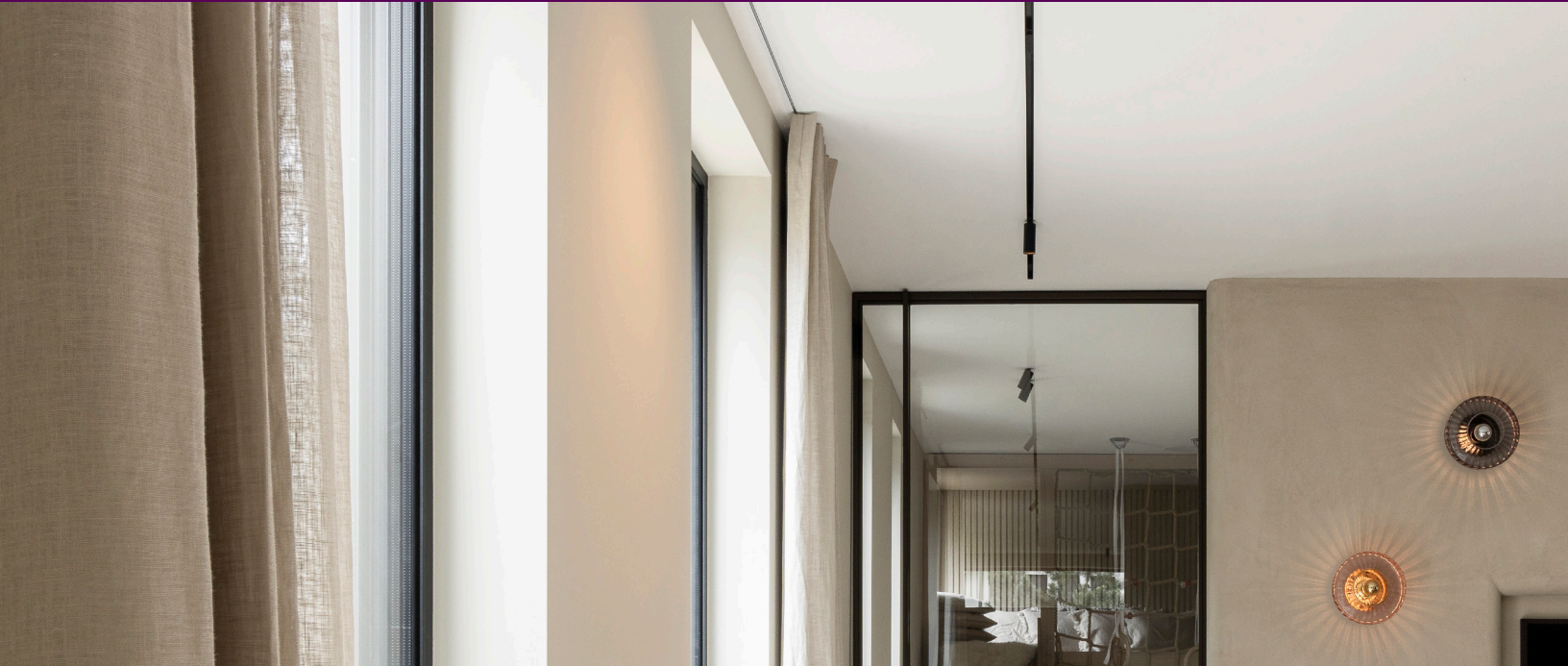

25
White

NEW!

CS[®] RECESS CONTRACT SYSTEM

- Heavy duty aluminum extrusion, powder coated, and lubricated with a patented process.
- Maximum weight is 6 lbs/ft.
- CS Recess track can be bent. An exact size template is required. See pages 97-98 for more information.
- Hand or baton draw, one or two way.
- Stackback: Ripplefold - 6" per width, pinchpleat - 7" per width, cubicle - 5" per width.

ASSEMBLED SYSTEM

Includes track, masters, pinchpleat or ripplefold carriers, brackets, short end cap, and 36" white fiberglass baton.

BATON OPTIONS

White fiberglass batons are available in 36", 48", 60", and 72" lengths. See all baton options at the end of the brochure.



25
White









59
Black



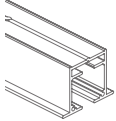
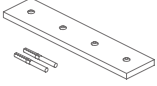

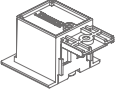
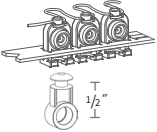
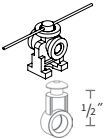





81
Bronze

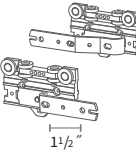
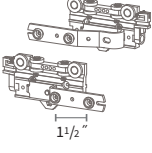
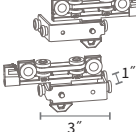

90
Grey

CS RECESS	COMPONENT
•	 <p>52019-25 white 19.7' CS Recess Track</p>
•	 <p>3910-90 CS Recess Track Connector</p>
•	 <p>52314-25 CS Recess End Cap Short Metal, powder coated</p>
•	 <p>52311-25 CS Recess End Cap Long Metal, powder coated</p>
•	<p>Wheeled Connected Snap Carrier with pendant, on plastic strip</p> <p>2207-25 60% fullness, 2 5/8" OC</p> <p>2206-25 80% fullness, 2 3/8" OC</p> <p>2205-25 100% fullness, 2 1/8" OC</p> <p>2208-25 120% fullness, 1 7/8" OC</p> 
•	<p>Wheeled Connected Snap Carrier with pendant, in plastic sleeve</p> <p>2107-25, 59 black 60% fullness, 2 5/8" OC</p> <p>2106-25, 59 black 80% fullness, 2 3/8" OC</p> <p>2105-25, 59 black 100% fullness, 2 1/8" OC</p> <p>2108-25, 59 black 120% fullness, 1 7/8" OC</p> 
•	 <p>2007-25 59 black Pendant for Snap Tape Carrier</p>
•	 <p>2008-25 59 black, Short Pendant for Snap Tape Carrier</p>
•	 <p>2004-25 59 black, 65 brown, 90 grey Snap Carrier for accordiafold</p>
•	 <p>52002-25 59 black, 65 brown, 90 grey Slim Line Ball Bearing Carrier</p>

CS RECESS	COMPONENT
•	 <p>52008-25 Slim Line Klick Carrier draperies hang to conceal track</p>
•	 <p>52108-25 Stop Carrier prevents slide back</p>
•	 <p>52100-25 59 black, 65 brown, 90 grey Ball Bearing Carrier w/ Stainless Hook slim line - use w/ grommets</p>
•	 <p>52502-25 Overlap R 52504-25 Underlap L 59 black Standard Multi-Functional Master Use stiffener w/ exposed baton or hooks w/ hidden baton</p>
•	 <p>52502-25A Overlap R 52504-25A Underlap L 59A black Standard Multi-Functional Master w/ snaps and baton adaptor</p>
•	 <p>52411-25A Butt R 52412-25A Butt L 59A black, 65A brown, 90A grey Wheeled Butt Master w/snap adaptor Designed for hidden baton</p>
•	 <p>2552-25 6" Extension Arm for master Use w/ two one-way draws</p>
•	 <p>2551-25 Small Extension Arm</p>
•	 <p>2305-25 59 black, 65 brown, 90 grey Twist On End Stop</p>
•	 <p>52307-90 End Lock</p>
•	 <p>54110-25 36" Fiberglass Baton w/ snap</p>

• Standard item in assembled sets.

FOREST CS[®] RECESS SPECIFICATIONS



PRODUCT INFORMATION

Our CS is now also offered as the CS Recess model. Special care and attention have been given to the track joining method and end caps. The CS Recess brings a touch of luxury to any space with its seamless ceiling integration, providing a refined and graceful finish. Use with pinch pleat or ripplefold drapery.

PROFILE

- Weight: 4.14 ounce per ft.
- Dimensions: 7/8" x 7/8"
- Pre-drilled holes every 10"

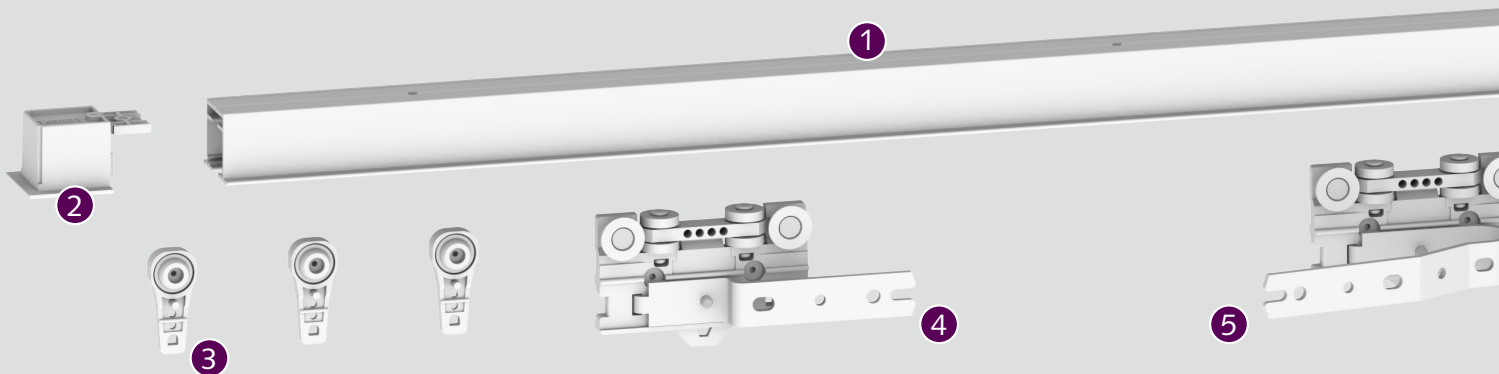
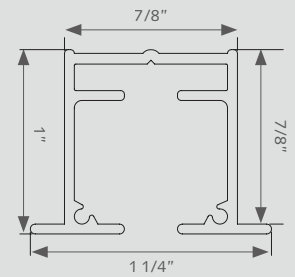



BENDING / CURVING

CS Recess can bent and reverse bent using an 8" radius. Actual size template is required.



APPLICATIONS

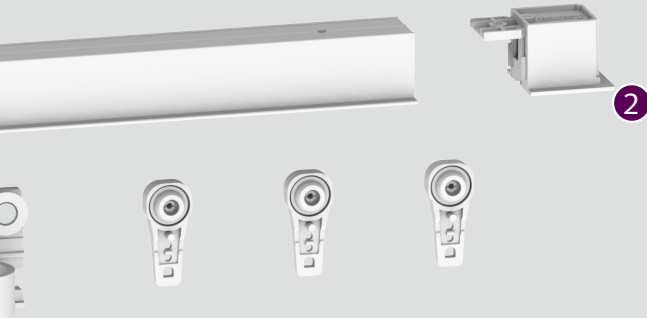
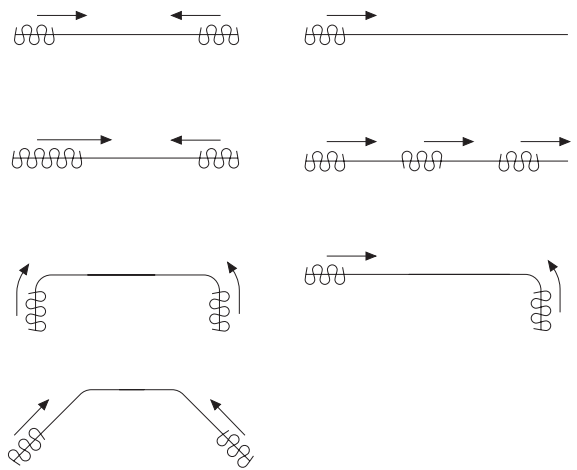

- ① CS Recess Track, 52019-25
- ② CS Recess End Cap Long, 52311-25
- ③ Slim Line Ball Bearing Carrier, 52002-25
- ④ Standard Master Carrier Underlap, 52504-25
- ⑤ Standard Master Carrier Overlap, 52502-25

* Ripplefold carriers and masters are also available

CLICK-ON STIFFENER

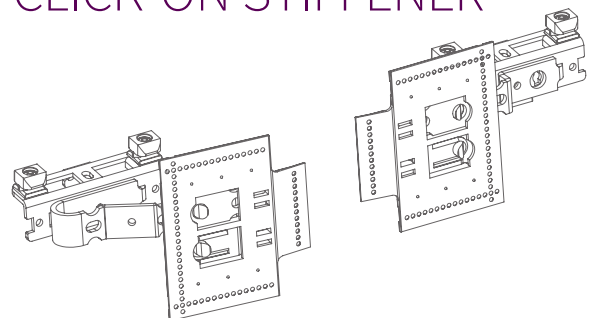

FOREST BATONS

BATONS

COMPONENT



• **3/8" Fiberglass Baton**
Must order screw separately

36"
54110-25 white w/ snap
54310-25 white w/ adaptor

54110-59, 81, 90
w/ snap

48"
54111-25 white w/ snap
54311-25 white w/ adaptor

54111-59, 81, 90
w/ snap

60"
54112-25 white w/ snap
54312-25 white w/ adaptor

54112-59, 81, 90
w/ snap





72"
54113-25 white w/ snap
54313-25 white w/ adaptor

54113-59, 81, 90
w/ snap

84"
54114-25 white w/ snap

96"
54115-25 white w/ snap

Colors available for 3/8" Fiberglass Batons

			
25 White	59 Black	81 Bronze	90 Grey

BATONS

COMPONENT



• **1/2" Clear Acrylic Baton**
Must order screw separately

36"
54510-00 w/ snap
54710-00 w/ adaptor

48"
54511-00 w/ snap
54711-00 w/ adaptor

60"
54512-00 w/ snap
54712-00 w/ adaptor

72"
54513-00 w/ snap
54713-00 w/ adaptor

• **ADA Clear Acrylic Baton**

48"
54911-00 w/ adaptor

60"
54912-00 w/ adaptor



• **9013-00**
Baton Holder, clear acrylic

• **54001-16**
Baton Snap

• **9015-00**
Hex Head Shoulder Screw
for baton w/ adaptor

• **54000-16**
D-Ring

Forest specializes in the development, production and supply of highly innovative drapery tracks and window coverings. We offer track solutions catering to the hospitality industry. Whether you choose our motorized tracks or rods, shades or hand drawn rods your client will experience comfortable luxury and optimal ease of use.

THE WORLD BEHIND YOUR DRAPERIES

More than thirty years ago it started with a flexible aluminum system, known as the Forest KS® system. The product line was expanded at a rapid pace, always focusing on functionality and quality. The technologies conquered the world. Hotels across the globe are satisfied users of Forest systems including iconic hotels like the Venetian, Hardrock and the mega hotels in Dubai.

Forest Group B.V. sells its products in more than 100 countries worldwide and has sales offices in The Netherlands, the United States, China, United Arab Emirates, United Kingdom and Poland, ensuring global availability.

Some well-known and recognized features of the Forest track systems are:

- **High-quality standards:** We guarantee a long lifespan.
- **Comfort and quiet:** Drapes open and close silently, creating a serene and comfortable environment.
- **Adds style to windows:** Always perfectly hanging drapery thanks to our systems, including motorized solutions.
- **Smart integration:** Controllable via app, voice, and home automation systems for ultimate convenience.
- **Sustainability:** We use a minimum of 75% recycled aluminum in our tracks.
- **Unique warranty:** 10-year warranty.



Drapery engineering by Forest