



CCS[®] TRACK

Forest tracks are installed in more than 100 countries worldwide. With a 10 year warranty, they are characterized by the strength of the extrusion, powder coated surface, and a patented dry lubricant.

CCS[®] CORDED CONTRACT SYSTEM

THE WORLD
BEHIND
YOUR
DRAPERIES



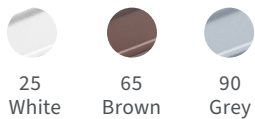









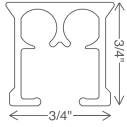
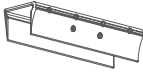





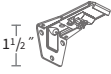
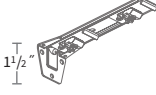

CCS® CORDED CONTRACT SYSTEM

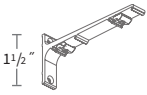
- Aluminum extrusion, powder coated and lubricated with a patented process.
- Maximum weight is 48 lbs per system. Maximum height is 12 ft. Maximum width is 16 ft.
- CCS Track can be bent and curved. An exact size template is required.
- Cord draw, one or two way.
- Stackback: Ripplefold - 6" per width, pinchpleat - 7" per width, accordiafold - 5" per width.
- All Forest corded products include a child safety tension device and warning label.

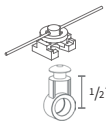
ASSEMBLED SYSTEM

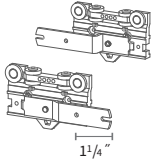
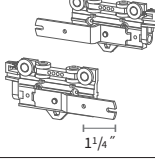
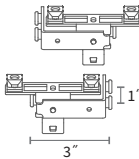
Includes track, masters, pinchpleat or ripplefold carriers, brackets, cord, tension pulley, child safety device. Freight is additional.

CCS	COMPONENT
• 	CCS Contract Cord Track 20 tracks/bundle 51116-25 white 16' 51116-65 brown 16' 51116-90 grey 16'
• 	3906-25 65 brown, 90 grey Track Connector
• 	52801-25 90 grey End Pulley, 2 1/4" Reversible Use on right or left
• 	52801-25A Right 52801-25B Left End Pulley w/ Snap 2 1/4 Reversible, for Ripplefold
• 	52803-25 65 brown, 90 grey Small End Pulley 1 1/2" Reversible, use with Butt Masters and one-way draw
• 	3001-25 90 grey Regular Duty Ceiling Bracket
• 	3003-25 65 brown, 90 grey Heavy Duty Ceiling Bracket w/ Smart Klick
• 	30031-25 65 brown, 90 grey Ceiling Bracket Cover use with 3003-XX
• 	53202-25 65 brown, 90 grey 3" Smart Klick Wall Bracket w/ wide base, adjusts 3-4.5"
• 	53206-25 65 brown, 90 grey 6" Smart Klick Double Wall Bracket w/ wide base adjusts 2.5"-4" & 6"-7.5"
• 	3280-25 65 brown, 90 grey 3" Wall Bracket, heavy duty projection 2 1/2"
• 	3285-25 90 grey 4" Wall Bracket, heavy duty projection 3 1/2"

CCS	COMPONENT
• 	3281-25 90 grey 6" Double Wall Bracket, heavy duty projection 1 1/2", 5 1/2"
• 	32801-25 90 grey Wall Bracket Cover use with 3280, 3285 & 3281
• 	Two Piece Connected Snap Carrier w/ Square Base, in plastic sleeve. Use 1 1/4" snap tape 2114-25 60% fullness, 2 5/8" OC 2111-25 80% fullness, 2 3/8" OC 2112-25 100% fullness, 2 1/8" OC 2115-25 120% fullness, 1 7/8" OC
• 	52008-25 65 brown Slim Line Klick Carrier draperies hang to conceal track
• 	52004-25 Low Profile Ball Bearing
• 	52508-25 Overlap R 52509-25 Underlap L 65 brown, 90 grey Swivel Foot Multi-Functional Master 1 1/4"
• 	52508-25A Overlap R 52509-25A Underlap L 65 brown, 90 grey Swivel Foot Multi-Functional Master w/ snaps 1 1/4"
• 	52410-25 Butt R 52409-25 Butt L Standard Butt Master w/ snaps for baton use 1" 3"
• 	52510-25 65 brown Cord Connector
• 	9004-25 3.2mm Cord 333.34 yds./roll
• 	49502-00 Tension Device for child safety

• Standard item in assembled sets.

FOREST CCS® SPECIFICATIONS



PRODUCT INFORMATION

- Heavy duty cord operated system, with separate internal cord channels; preventing cord sag and eliminating cord tangle.
- Quick installation with “Smart Klick”. brackets for wall and ceiling applications.
- Bendable; it can be curved and reversed curved with a 8” radius or continuous curve.
- Heavy duty clickable carriers - 10 carriers on a breakaway strip - UV protected.
- Can also be used for Forest Easyfold and accordiafold drapery systems.
- Maximum fabric weight is 50 lbs. per system.
- Track finish: chromated powder coating with a factory applied patented dry lubricant.
- Warranty: 10 years.



Easy installation
click - position - tighten



Clickable carrier

PROFILE

- Shown actual size 1:1
- Aluminum Extrusion
- Weight: 3.22 ounce per ft
- Dimensions: 3/4” x 3/4”

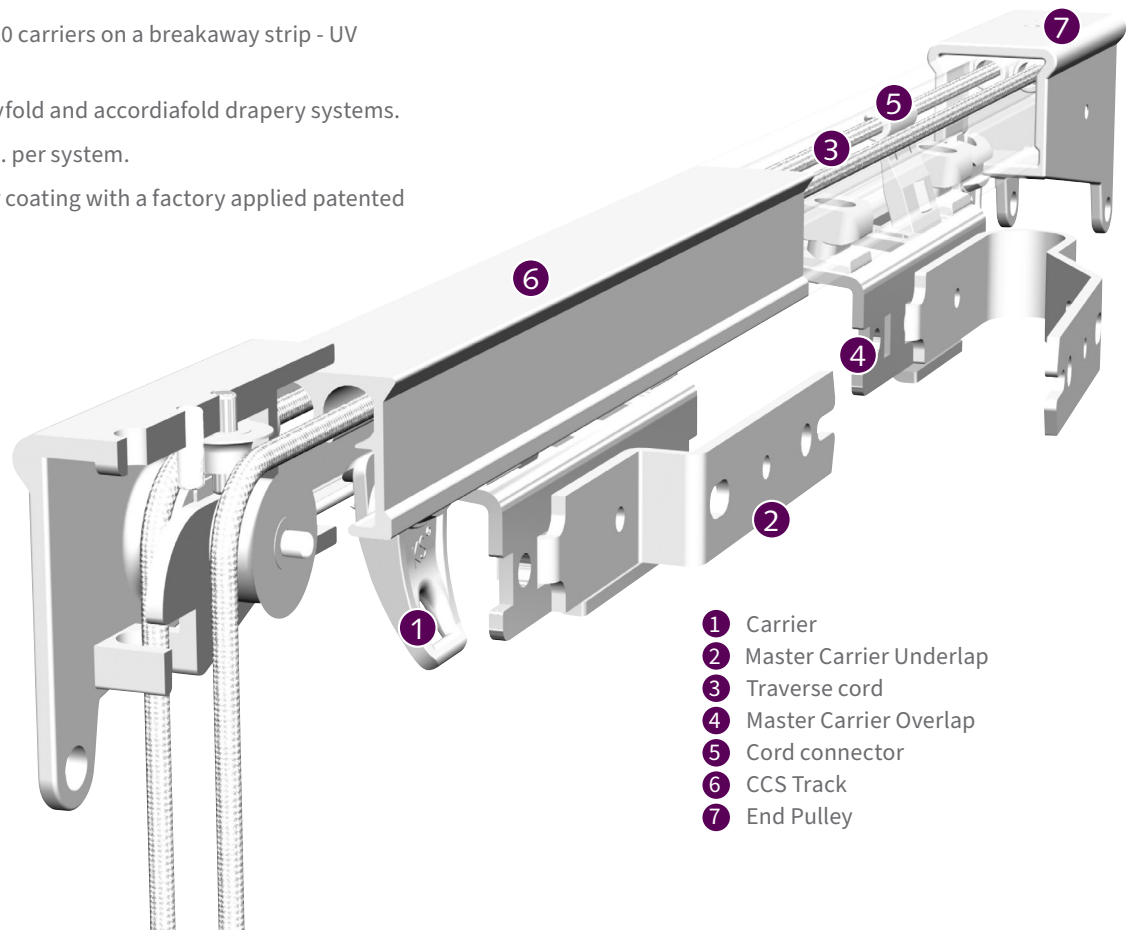
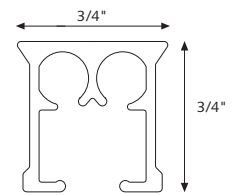

- 1 Carrier
- 2 Master Carrier Underlap
- 3 Traverse cord
- 4 Master Carrier Overlap
- 5 Cord connector
- 6 CCS Track
- 7 End Pulley



MOUNTING BRACKETS

Smart Klick Ceiling Bracket with cover

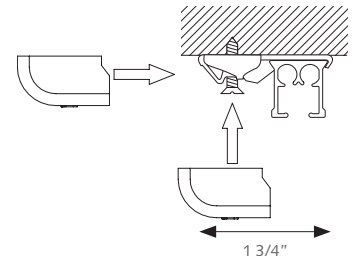

Smart Klick Single Wall Bracket

- A) 3" B) 2 1/2"
- A) 4" B) 3 1/2"

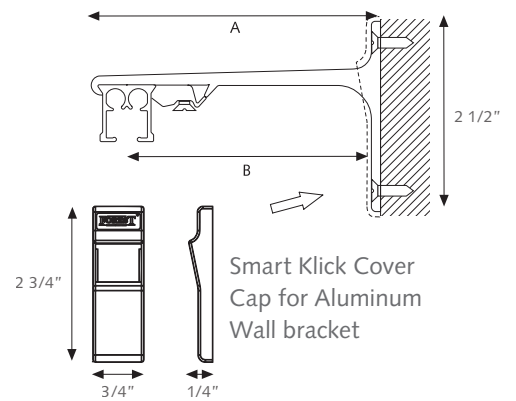

Smart Klick Wall Double Wall Bracket

- A) 6" B) 3 1/2" C) 1 3/4"

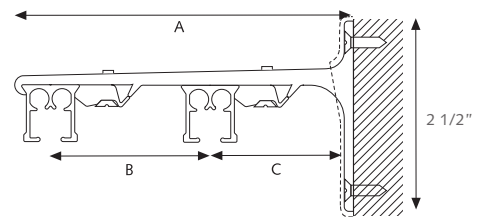

Brackets need to be placed every 36", depending on fabric weight.

APPLICATIONS

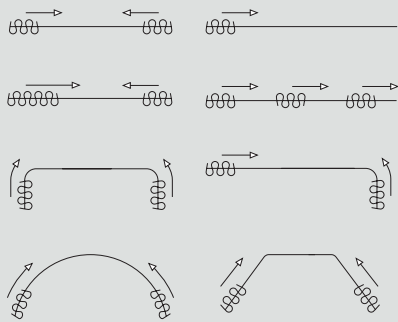

BENDING / CURVING

The track can be curved and reversed curved using an 8" radius. Continuous curving can be done with the electric powered bender.



FOR USE IN

Hotels - motels - offices - healthcare - schools - residential or any location where a cord operated system is required.

Forest specializes in the development, production and supply of highly innovative drapery tracks and window coverings. We offer track solutions catering to the hospitality industry. Whether you choose our motorized tracks or rods, shades or hand drawn rods your client will experience comfortable luxury and optimal ease of use.

THE WORLD BEHIND YOUR DRAPERIES

More than thirty years ago it started with a flexible aluminum system, known as the Forest KS® system. The product line was expanded at a rapid pace, always focusing on functionality and quality. The technologies conquered the world. Hotels across the globe are satisfied users of Forest systems including iconic hotels like the Venetian, Hardrock and the mega hotels in Dubai.

Forest Group B.V. sells its products in more than 100 countries worldwide and has sales offices in The Netherlands, the United States, China, United Arab Emirates, United Kingdom and Poland, ensuring global availability.

Some well-known and recognized features of the Forest track systems are:

- **High-quality standards:** We guarantee a long lifespan.
- **Comfort and quiet:** Drapes open and close silently, creating a serene and comfortable environment.
- **Adds style to windows:** Always perfectly hanging drapery thanks to our systems, including motorized solutions.
- **Smart integration:** Controllable via app, voice, and home automation systems for ultimate convenience.
- **Sustainability:** We use a minimum of 75% recycled aluminum in our tracks.
- **Unique warranty:** 10-year warranty.



Drapery engineering by Forest