



DS[®] TRACK



MANUAL
OPERATION

Forest tracks are installed in more than 100 countries worldwide. With a 10 year warranty, they are characterized by the strength of the extrusion, powder coated surface, and a patented dry lubricant.

DS[®] DESIGN SYSTEM

THE WORLD
BEHIND
YOUR
DRAPERIES

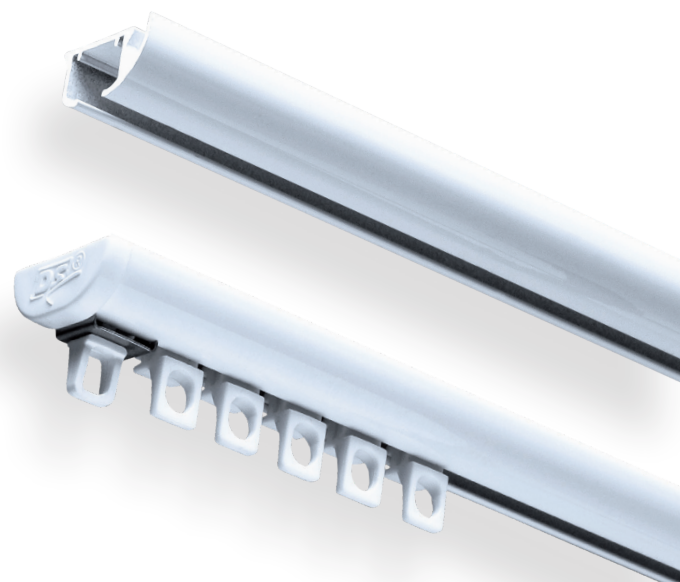

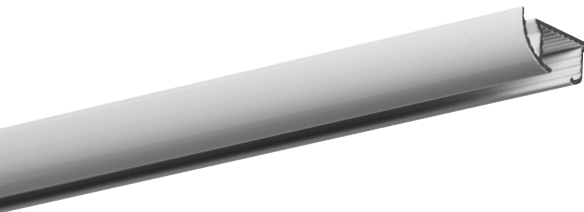

25
White



89
Graphite

DS® DESIGN SYSTEM

- Aluminum extrusion, powder coated and lubricated with a patented process.
- Maximum weight is 3 lbs/ft.
- DS tracks can be bent and curved. An exact size template is required. See pages 97-98 for more information.
- Hand or baton draw, one or two way.
- Stackback per width: ripplefold - 6", pinchpleat - 7", cubicle - 5", accordiafold - 5".

ASSEMBLED PRICING

Includes track, masters, pinchpleat or ripplefold carriers, brackets, and 36" white fiberglass baton.

BATON OPTIONS

White fiberglass batons are available in 36", 48", 60", and 72" lengths. See all baton options at the end of brochure.



25
White









59
Black



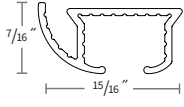
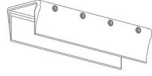





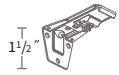
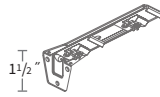
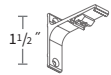
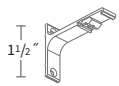
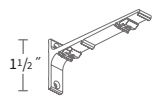

81
Bronze

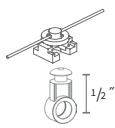

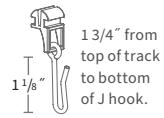
90
Grey

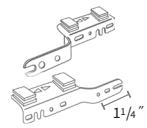
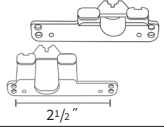
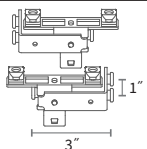
DS	COMPONENT
•	 <p>DS Design System Track 1116-25 white 16' 4" 1119-89 graphite 19' 7"</p>
•	 <p>3905-25 59 black, 90 grey Track Connector key 3904-00</p>
•	 <p>2310-25 89 graphite DS End Cap w/ screw</p>
•	 <p>9100-00 Channel Protector</p>
•	 <p>3001-25 59 black, 90 grey Regular Duty Ceiling Bracket</p>
•	 <p>3901-25 59 black Ceiling Splice/Bracket</p>
•	 <p>3003-25 59 black, 65 brown, 90 grey Heavy Duty Ceiling Bracket w/ Smart Klick</p>
•	 <p>30031-25 59 black, 65 brown, 90 grey Ceiling Bracket Cover use with 3003-XX</p>
•	 <p>53202-25 59 black, 65 brown, 90 grey 3" Smart Klick Wall Bracket w/ wide base, adjusts 3-4.5"</p>
•	 <p>53206-25 59 black, 65 brown, 90 grey 6" Smart Klick Double Wall Bracket w/ wide base adjusts 2.5"-4" & 6"-7.5"</p>
•	 <p>3280-25 59 black, 65 brown, 90 grey 3" Wall Bracket, heavy duty projection 2 1/2"</p>
•	 <p>3285-25 59 black, 90 grey 4" Wall Bracket, heavy duty projection 3 1/2"</p>
•	 <p>3281-25 59 black, 90 grey 6" Double Wall Bracket, heavy duty projection 1 1/2", 5 1/2"</p>

DS	COMPONENT
•	 <p>32801-25 59 black, 90 grey Wall Bracket Cover use with 3280, 3285 & 3281</p>
•	 <p>2001-25 59 black, 65 brown, 90 grey Klick Carrier, for pinch pleat</p>
•	 <p>2004-25 59 black Snap Carrier, for accordiafold</p>
•	 <p>Two Piece Connected Snap Carrier w/ Square Base Use 1 1/4" snap tape 2114-25, 59 black 60% fullness, 2 5/8" OC 2111-25, 59 black 80% fullness, 2 3/8" OC 2112-25, 59 black 100% fullness, 2 1/8" OC 2115-25, 59 black 120% fullness, 1 7/8" OC</p>
•	 <p>52003-25 65 brown Economy Slide</p>
•	 <p>52004-25 Low Profile Ball Bearing Carrier</p>
•	 <p>2201-25 59 black Klick Carrier w/ Stainless Hook Use with grommets 1 3/4" from top of track to bottom of J hook. 1 1/8"</p>
•	 <p>52005-25 Button Slide Carrier 52105-25 Button Slide Carrier w/ Hook</p>
•	 <p>2525-25 Overlap R 2526-25 Underlap L 2527-25 Overlap L 2528-25 Underlap R Pinchpleat Masters 1 1/4"</p>
•	 <p>B8809-23-00 Overlap R B8809-24-00 Underlap L 59 black Plastic Snap Master 2 1/2"</p>
•	 <p>52410-25 Butt R 52409-25 Butt L 59 black Standard Butt Master w/ snaps and for baton use 1" 3"</p>
•	 <p>2305-25 59 black, 65 brown, 90 grey Twist On End Stop</p>
•	 <p>54110-25 36" Fiberglass Baton w/ snap.</p>

• Standard item in assembled sets.

FOREST DS[®] SPECIFICATIONS



PRODUCT INFORMATION

- Elegant and aesthetically pleasing hand drawn system for light weight draperies.
- Quick installation with “Smart Klick” brackets for wall and ceiling applications.
- Hidden brackets are behind the elegant shape of the track.
- Heavy duty clickable carriers are UV protected and offer smooth, easy traversing.
- Can be used with pinchpleat, ripplefold and accordiafold draperies.
- Recommended maximum fabric weight is 3 lbs./ft.
- Track finish is a chromated powder coating with a factory applied patented dry lubricant.
- Limited lifetime warranty.

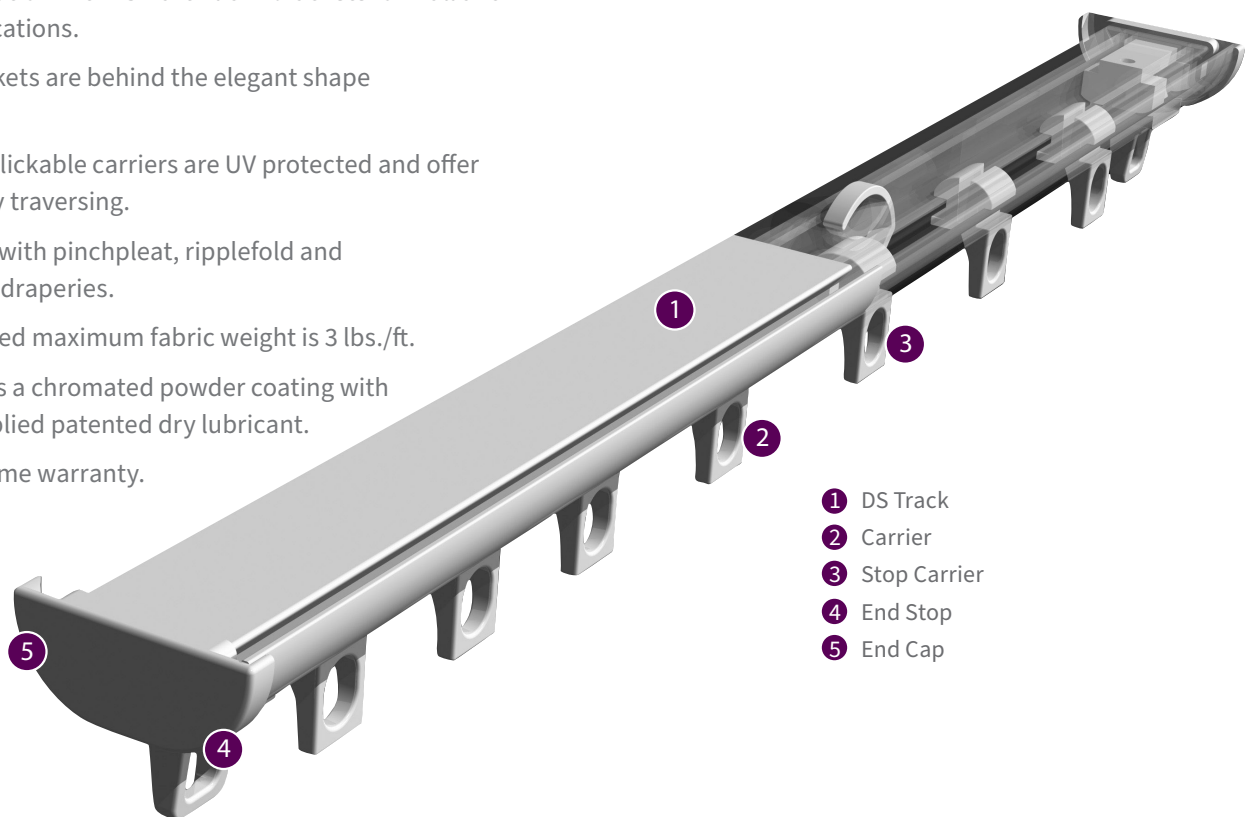



PROFILE

- Aluminum Extrusion
- Dimensions: 15/16" x 7/16"

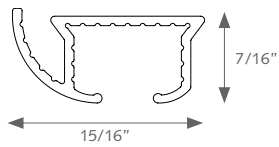

FOR USE IN

Hotels, motels, offices, schools, healthcare facilities, residences or at any location where an elegant hand drawn system is desired.

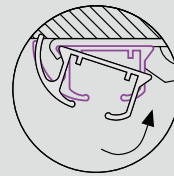

Easy installation
click - position - tighten

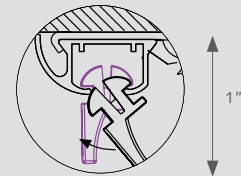

clickable carrier

APPLICATIONS

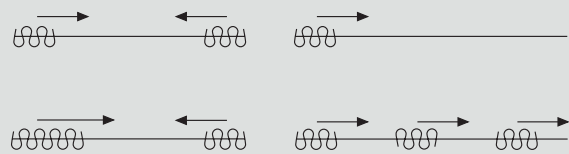

MOUNTING BRACKETS

Brackets need to be placed every 24".

Heavy Duty Ceiling Bracket with Smart Klick 3003-XX

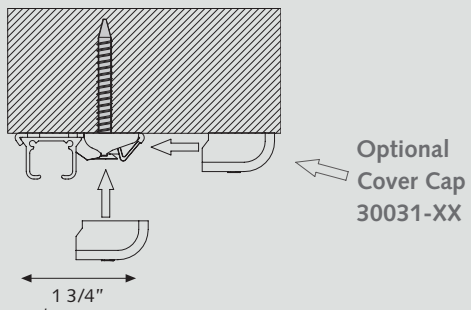

3" Smart Klick Wall Bracket 53202-XX

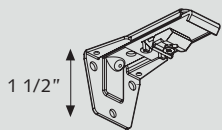

6" Smart Klick Double Wall Bracket 53206-XX

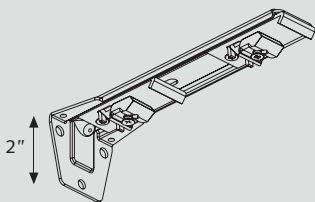

3" Wall Bracket for Wood Poles 3280-XX

- A) 3" B) 2 1/2"
A) 5" B) 4 1/2"

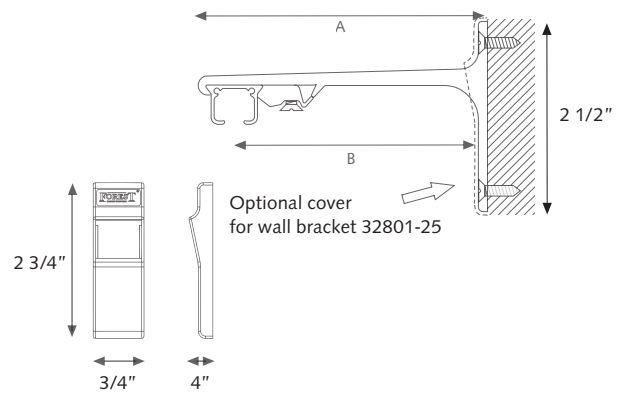





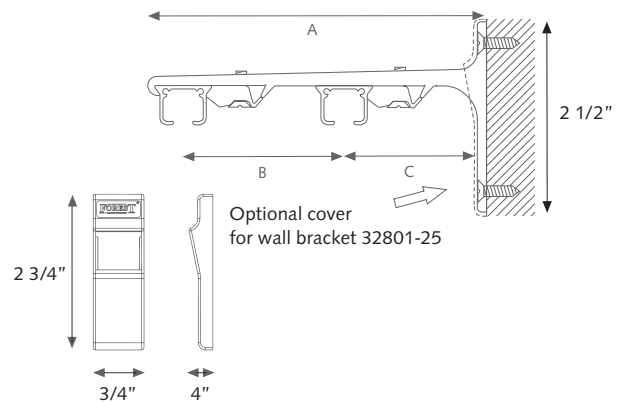

6" Double Wall Bracket for Wood Poles 3281-XX

- A) 6" B) 3 5/8" C) 1 3/4"
A) 8" B) 3 5/8" C) 3 3/4"



BATONS – FIBERGLASS, ACRYLIC, ADA & COMPONENTS

BATONS	COMPONENT
	<p>3/8" Fiberglass Baton Must order screw separately</p> <p>36" 54110-25 white w/ snap 54310-25 white w/ adaptor</p> <p>54110-59, 81, 90 w/ snap</p> <p>48" 54111-25 white w/ snap 54311-25 white w/ adaptor</p> <p>54111-59, 81, 90 w/ snap</p> <p>60" 54112-25 white w/ snap 54312-25 white w/ adaptor</p> <p>54112-59, 81, 90 w/ snap</p> <p>72" 54113-25 white w/ snap 54313-25 white w/ adaptor</p> <p>54113-59, 81, 90 w/ snap</p> <p>84" 54114-25 white w/ snap</p> <p>96" 54115-25 white w/ snap</p>
	<p>Colors available for 3/8" Fiberglass Batons</p> <div style="display: flex; justify-content: space-around; align-items: center;"> <div style="text-align: center;">  25 White </div> <div style="text-align: center;">  59 Black </div> <div style="text-align: center;">  81 Bronze </div> <div style="text-align: center;">  90 Grey </div> </div>

BATONS	COMPONENT
	<p>1/2" Clear Acrylic Baton Must order screw separately</p> <p>36" 54510-00 w/ snap 54710-00 w/ adaptor</p> <p>48" 54511-00 w/ snap 54711-00 w/ adaptor</p> <p>60" 54512-00 w/ snap 54712-00 w/ adaptor</p> <p>72" 54513-00 w/ snap 54713-00 w/ adaptor</p>
	<p>ADA Clear Acrylic Baton</p> <p>48" 54911-00 w/ adaptor</p> <p>60" 54912-00 w/ adaptor</p>
	<p>9013-00 Baton Holder, clear acrylic</p>
	<p>54001-16 Baton Snap</p>
	<p>9015-00 Hex Head Shoulder Screw for baton w/ adaptor</p>
<p>54000-16 D-Ring</p>	

BATONS – DECORATIVE METAL & WOOD

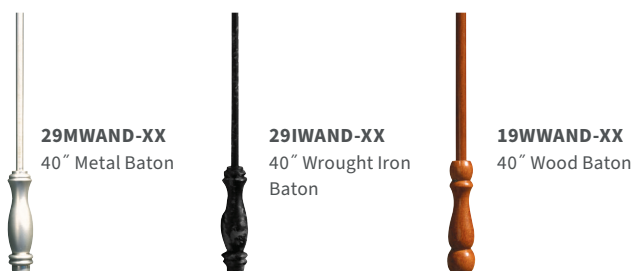

Forest specializes in the development, production and supply of highly innovative drapery tracks and window coverings. We offer track solutions catering to the hospitality industry. Whether you choose our motorized tracks or rods, shades or hand drawn rods your client will experience comfortable luxury and optimal ease of use.

THE WORLD BEHIND YOUR DRAPERIES

More than thirty years ago it started with a flexible aluminum system, known as the Forest KS® system. The product line was expanded at a rapid pace, always focusing on functionality and quality. The technologies conquered the world. Hotels across the globe are satisfied users of Forest systems including iconic hotels like the Venetian, Hardrock and the mega hotels in Dubai.

Forest Group B.V. sells its products in more than 100 countries worldwide and has sales offices in The Netherlands, the United States, China, United Arab Emirates, United Kingdom and Poland, ensuring global availability.

Some well-known and recognized features of the Forest track systems are:

- **High-quality standards:** We guarantee a long lifespan.
- **Comfort and quiet:** Drapes open and close silently, creating a serene and comfortable environment.
- **Adds style to windows:** Always perfectly hanging drapery thanks to our systems, including motorized solutions.
- **Smart integration:** Controllable via app, voice, and home automation systems for ultimate convenience.
- **Sustainability:** We use a minimum of 75% recycled aluminum in our tracks.
- **Unique warranty:** 10-year warranty.



Drapery engineering by Forest